

DRAWING/DESSIN	REV.	DATE	DRAWING/DESSIN	REV.	DATE	DRAWING/DESSIN	REV.	DATE
M001	1	2019/11/28	P050	2	2019/11/28	M101	1	2019/11/28
B002	2	2019/11/28	P051	2	2019/11/28	M102	1	2019/11/28
B003	3	2019/11/28	P052	2	2019/11/28	M103	1	2019/11/28
B004	4	2019/11/28	P053	3	2019/11/28	M104	1	2019/11/28
B005	3	2019/11/28	P054	2	2019/11/28	M105	1	2019/11/28
B006	3	2019/11/28	P055	2	2019/11/28	M106	1	2019/11/28
B007	2	ANNULE	P056	1	2019/11/28	M107	1	2019/11/28
B008	2	ANNULE	P057	1	2019/11/28	M108	1	2019/11/28
B009	3	2019/11/28	P058	1	2019/11/28	M109	1	2019/11/28
B127	0	2019/11/28	P059	1	2019/11/28	M110	1	2019/11/28
V010	1	2019/11/28	P060	1	2019/11/28	M111	1	2019/11/28
V011	1	2019/11/28	P061	1	2019/11/28	M112	1	2019/11/28
V012	1	2019/11/28	P062	1	2019/11/28	M113	1	2019/11/28
V013	1	2019/11/28	P063	1	2019/11/28	M114	1	2019/11/28
V014	1	2019/11/28	P064	1	2019/11/28	M115	1	2019/11/28
V015	1	2019/11/28	P065	1	2019/11/28	M116	1	2019/11/28
V016	1	2019/11/28	P066	1	2019/11/28	M117	1	2019/11/28
V017	1	2019/11/28	P067	1	2019/11/28	M118	2	2019/11/28
V018	1	2019/11/28	P068	1	2019/11/28	M119	2	2019/11/28
V019	1	2019/11/28	P069	1	2019/11/28	M120	4	2019/11/28
V020	1	2019/11/28	P070	2	2019/11/28	M121	1	2019/11/28
V021	1	2019/11/28	P071	2	2019/11/28	M122	1	2019/11/28
V126	0	2019/11/28	P072	2	2019/11/28	M128	0	2019/11/28
X022	2	2019/11/28	P073	2	2019/11/28	E123	1	2019/11/28
X023	1	2019/11/28	P074	1	2019/11/28	E124	1	2019/11/28
X024	2	2019/11/28	P075	1	2019/11/28	E125	1	2019/11/28
X025	2	2019/11/28	P076	1	2019/11/28			
X026	1	2019/11/28	P077	2	2019/11/28			
X027	2	2019/11/28	P078	1	2019/11/28			
X028	2	2019/11/28	R079	1	2019/11/28			
H029	2	2019/11/28	R080	1	2019/11/28			
H030	2	2019/11/28	E081	2	2019/11/28			
H031	2	2019/11/28	E082	2	2019/11/28			
H032	2	2019/11/28	M083	1	2019/11/28			
P033	3	2019/11/28	E084	2	2019/11/28			
P034	3	2019/11/28	E085	2	2019/11/28			
P035	3	2019/11/28	E086	2	2019/11/28			
P036	3	2019/11/28	E087	1	2019/11/28			
H037	2	2019/11/28	E088	1	2019/11/28			
H038	2	2019/11/28	E089	1	2019/11/28			
H039	2	2019/11/28	P090	1	2019/11/28			
H040	2	2019/11/28	P091	1	2019/11/28			
P041	3	2019/11/28	P092	1	2019/11/28			
P042	3	2019/11/28	P093	1	2019/11/28			
P043	3	2019/11/28	E094	3	2019/11/28			
P044	3	2019/11/28	E095	3	2019/11/28			
P045	2	2019/11/28	E096	3	2019/11/28			
P046	2	2019/11/28	E097	3	2019/11/28			
P047	2	2019/11/28	E098	3	2019/11/28			
P048	2	2019/11/28	E099	3	2019/11/28			
P049	2	2019/11/28	M100	1	2019/11/28			



5	REVISION GENERALE (CIMA+)	2019/11/28
4	M119 REVIS E123,E124,E125 AJOUT	2011/01/06
3	P073, E094 & E099 & M120 REV X022,X024,X025,X027 & P055,P070	2006/03/22
2	B003 & B009 REVISED/REVISED	2006/02/09
1	B002 & B009 REVISED/REVISED	2006/01/25
No	REVISION	DATE



Pêches et Océans
Canada

Garde côtière

Coast Guard



DESSIN MICHEL VACHON INC.
DESSIN DE STRUCTURES METALLIQUES
11-COCHON (Mtl) 568-7960

DRAWN: M.VACHON	CHECKED: M.VACHON	DATE: 2006/01/23
DESIGN: M.VACHON	VERIFIED: M.VACHON	DATE: 2006/01/23
SCALE: 1 = 1	FILE: 08990-SA	DRAWING: 00A/6
SHEET: 1	DOSSIER: 08990-SA	DESSIN: 00A/6

STEEL TOWERS / TOURS D'ACIER

HEIGHT OF TOWER / HAUTEUR DE LA TOUR	10'	15'	20'	25'	30'	35'	40'	45'	50'	55'	60'	65'	70'	75'	80'
QUANTITY REQUIRED / QUANTIT REQUISE	8	8	8	8	8	16	16	16	24	24	24	24	32	32	32
ERECTION DRAWING / DESSIN DE MONTAGE	08990-SM-01	08990-SM-02	08990-SM-03	08990-SM-04	08990-SM-05	08990-SM-06	08990-SM-07	08990-SM-08	08990-SM-09	08990-SM-10	08990-SM-11	08990-SM-12	08990-SM-13	08990-SM-14	08990-SM-15

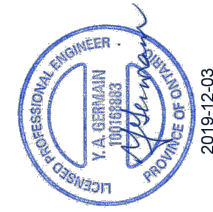
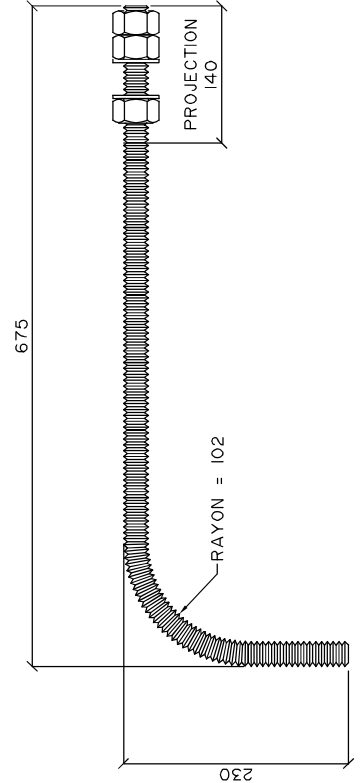

NOTE A : A193 B7
(Fu = 860 MPa)

No	REVISION GENERALE (CIMA+)	2019/11/28	DATE
	REVISION		
	Pêches et Océans Canada	Fisheries and Oceans Canada	
	Garde côtière Coast Guard		

DESSIN MICHEL VACHON INC. DESSIN DE STRUCTURES METALLIQUES 1 ^{er} FLOOR, 1140, RUE KENNEDY MONTRÉAL, QUÉBEC H3M 1S8			
STEEL TOWERS / TOURS D'ACIER			
MATERIAL / MATÉRIEL:	ASTM	UN FINISH / S.N. FINI:	GALV.
DRAWN / DESSIN:	M.VACHON	CHECKED / VÉRIFIÉ:	M.VACHON
SCALE / ÉCHELLE:	1 = 5	FILE / DOSSIER:	08990-SA
		DRAWING / DESSIN:	2005/11/29
			MOO

QTY	MRK	DESCRIPTION	LENGTH	GRADE	REMARK	WEIGHT	MRK	DESCRIPTION	LENGTH	GRADE	REMARK	WEIGHT
QT	MQE	DESCRIPTION	LONG.	NUANCE	REMARQUE	MASSE	MQE	DESCRIPTION	LONG.	NUANCE	REMARQUE	MASSE
-	MOO1	● 25.4 φ X	835	NOTE A	THREADED AND BEND / FILETE ET PLIE	3.5						
					C/W / C/A	0.6						
					3 NUTS / CROUS	0.1						
					2 WASH. / ROND.							

HEIGHT OF TOWER / HAUTEUR DE LA TOUR	10'	15'	20'	25'	30'	35'	40'	45'	50'	55'	60'	65'	70'	75'	80'
QUANTITY REQUIRED / QUANTITE REQUISE	4	4	4	0	0	0	0	0	0	0	0	0	0	0	0
ERECTION DRAWING / DESSIN DE MONTAGE	08990-SM-01	08990-SM-02	08990-SM-03	08990-SM-04	08990-SM-05	08990-SM-06	08990-SM-07	08990-SM-08	08990-SM-09	08990-SM-10	08990-SM-11	08990-SM-12	08990-SM-13	08990-SM-14	08990-SM-15

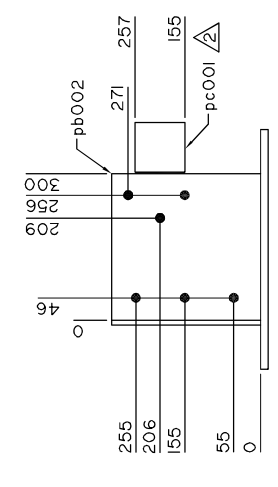
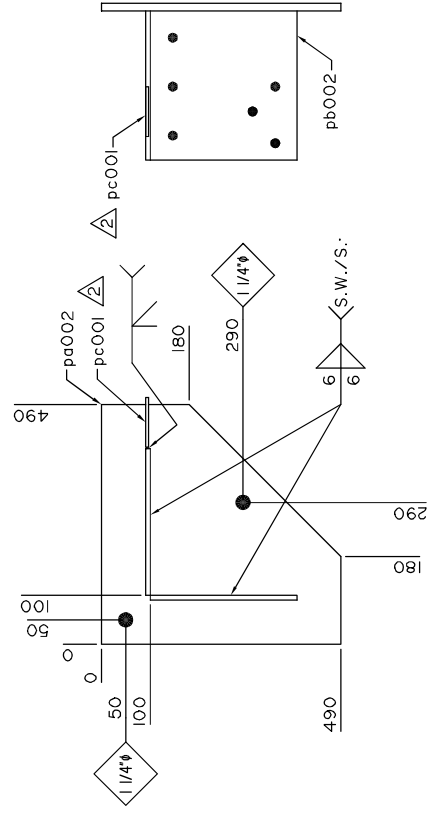

2020-01-14

2020-01-14

2	REVISION GENERALE (CIMA+)	2019/11/28
1	SOUDURE VERTICALE ENLEVÉ	2006/01/13
No	REVISION	DATE
Pêches et Océans Canada Garde côtière		

DESSIN MICHEL VACHON INC.
 DESSIN DE STRUCTURES METALLIQUES
 11-PROV. TEL: 514-749-5968
 1-CANADA TEL: 438-7768

STEEL TOWERS / TOURS D'ACIER		
MATERIAL: G40.21M	HOLES: 13/16" Ø	U.N. FINISH: GALV.
DRAWN: M.VACHON	TROUS: 3/8"	S.N. FINI: GALV.
DESIGNED: M.VACHON	CHECKED: M.VACHON	DATE: 2005/11/30
SCALE: 1 = 10	FILE DOSSIER: 08990-SA	DRAWING: B002

QTY	MRK	DESCRIPTION	LENGTH	GRADE	REMARK	WEIGHT	MRK	DESCRIPTION	LENGTH	GRADE	REMARK	WEIGHT
QT	MQE	DESCRIPTION	LONG.	NUANCE	REMARQUE	MASSE	MQE	DESCRIPTION	LONG.	NUANCE	REMARQUE	MASSE
1	pa002	PL 15.9 X 490	490	300W		30.1						
2	pb002	FB 9.53 X 305	300	300W	ASS. EB002	14.2						
1	pc001	PL 6.35 X 102	102	300W		0.5						

HEIGHT OF TOWER / HAUTEUR DE LA TOUR	10'	15'	20'	25'	30'	35'	40'	45'	50'	55'	60'	65'	70'	75'	80'
QUANTITY REQUIRED / QUANTITE REQUISE	0	0	0	4	4	0	0	0	0	0	0	0	0	0	0
ERECTION DRAWING / DESSIN DE MONTAGE	08990-SM-01	08990-SM-02	08990-SM-03	08990-SM-04	08990-SM-05	08990-SM-06	08990-SM-07	08990-SM-08	08990-SM-09	08990-SM-10	08990-SM-11	08990-SM-12	08990-SM-13	08990-SM-14	08990-SM-15

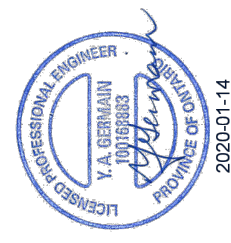
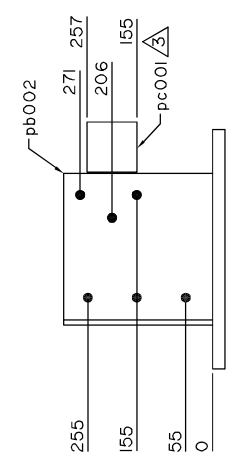
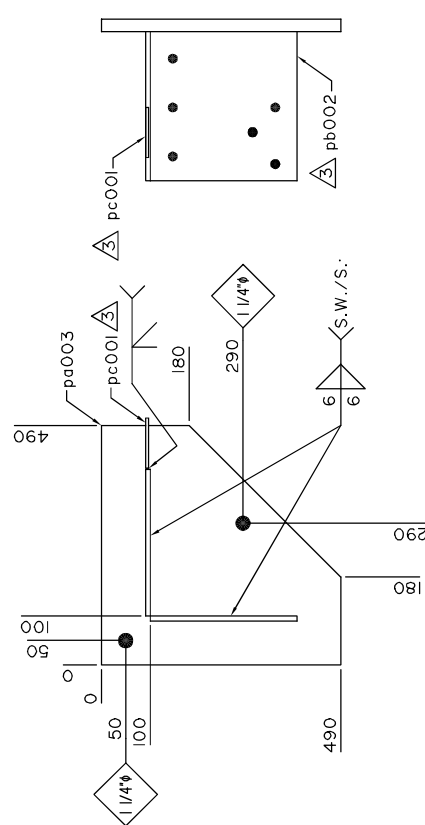

No	REVISION	DATE
3	REVISION GENERALE (CIMA+)	2019/11/28
2	SOUJURE REVISÉ	2006/02/09
1	SOUJURE VERTICALE ENLEVÉ	2006/01/13

Pêches et Océans
 Canada
 Gardie côtière
 Coast Guard

DESSIN MICHEL VACHON INC
 DESSIN DE STRUCTURES METALLIQUES
 1-PROVINC: 514-344-8888
 1-CANADA: 514-344-7888

QTY	MRK	DESCRIPTION	LENGTH	GRADE	REMARK	WEIGHT
QT	MQE	DESCRIPTION	LONG.	NUANCE	REMARQUE	MASSE
1	pa003	PL 25.4 X 490	490	300W		47.9
2	pb002	FB 9.53 X 305	300	300W	ASS. EB003	14.2
1	pc001	PL 6.35 X 102	102	300W		0.5

QTY	MRK	DESCRIPTION	LENGTH	GRADE	REMARK	WEIGHT
QT	MQE	DESCRIPTION	LONG.	NUANCE	REMARQUE	MASSE
1	pa003	PL 25.4 X 490	490	300W		47.9
2	pb002	FB 9.53 X 305	300	300W	ASS. EB003	14.2
1	pc001	PL 6.35 X 102	102	300W		0.5

MATERIAL: G40.21M U.N. FINISH: GALV.
 MATERIAL: TROUS: 13/16" Ø S.N. FINI: GALV.
 DRAWN: M.VACHON CHECKED: M.VACHON DATE: 2005/11/30
 DESSIN: M.VACHON VÉRIF: M.VACHON DATE: 2005/11/30
 SCALE: 1 = 10 FILE: 08990-SA DRAWING: B003/3
 DOSSIER: 08990-SA DESSIN: B003/3

STEEL TOWERS / TOURS D'ACIER

WEIGHT / MASSE: 62.6 Kg

REMARK / REMARQUE

LENGTH / LONG.

GRADE / NUANCE

DESCRIPTION / DESCRIPTION

MRK / MQE

QTY / QT

WEIGHT / MASSE

REMARK / REMARQUE

LENGTH / LONG.

GRADE / NUANCE

DESCRIPTION / DESCRIPTION

MRK / MQE

QTY / QT

WEIGHT / MASSE

REMARK / REMARQUE

HEIGHT OF TOWER / HAUTEUR DE LA TOUR	10'	15'	20'	25'	30'	35'	40'	45'	50'	55'	60'	65'	70'	75'	80'
QUANTITY REQUIRED / QUANTITE REQUISE	0	0	0	0	0	4	0	0	0	0	0	0	0	0	0
ERECTION DRAWING / DESSIN DE MONTAGE	08990-SM-01	08990-SM-02	08990-SM-03	08990-SM-04	08990-SM-05	08990-SM-06	08990-SM-07	08990-SM-08	08990-SM-09	08990-SM-10	08990-SM-11	08990-SM-12	08990-SM-13	08990-SM-14	08990-SM-15

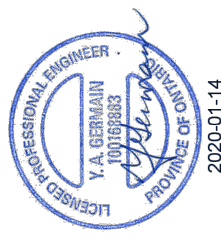
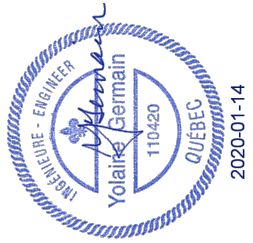
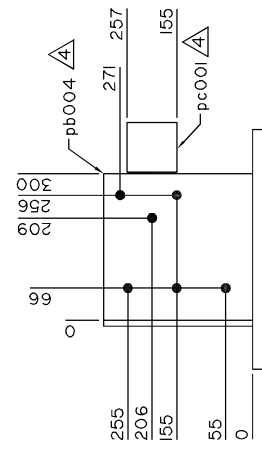
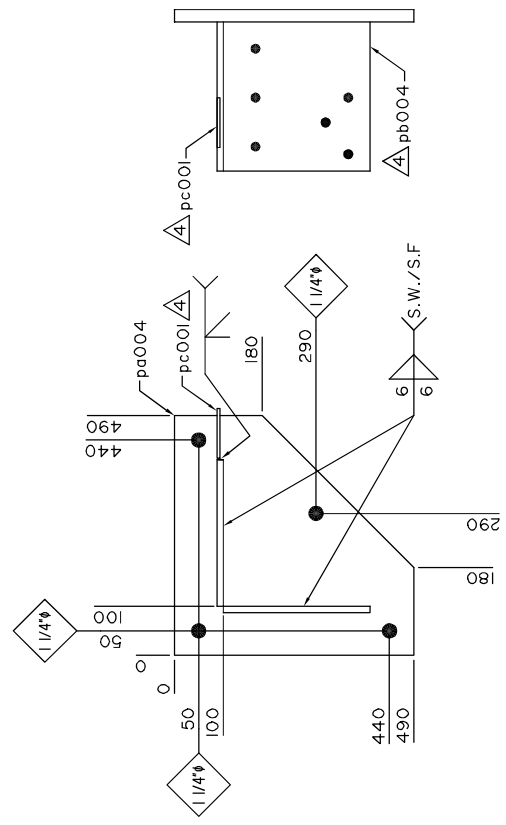

No	REVISION	DATE
4	REVISION GENERALE (CIMA+)	2019/11/28
3	CORRECTION ENLEVER TROU	2014/09/18
2	SOUJURE REVISE	2006/02/09
1	SOUJURE VERTICALE ENLEVE	2006/01/13

Pêches et Océans
 Canada

Gardie côtière
 Coast Guard

QTY	MRK	DESCRIPTION	LENGTH	GRADE	REMARK	WEIGHT
QT	MQE	DESCRIPTION	LONG.	NUANCE	REMARQUE	MASSE
1	pa004	PL 25.4 X 490	490	300W		47.9
2	pb004	FB 12.7 X 305	300	300W	ASS. EB004	18.2
1	pc001	PL 6.35 X 102	102	300W		0.5
_WEIGHT / MASSE: 66.6 Kg						

STEEL TOWERS / TOURS D'ACIER	
MATERIAL: G40.21M	U.N. FINISH: GALV.
MATERIAL: M.VACHON	U.N. FINISH: GALV.
DRAWN: M.VACHON	CHECKED: M.VACHON
DATE: 2005/11/30	DATE: 2005/11/30
SCALE: 1 = 10	FILE: 08990-SA
DRAWING: B004	DESSIN: B004



DESIGN MICHEL VACHON INC.
 DESSIN DE STRUCTURES METALLIQUES
 11-PROV. TEL: 438-338-3388
 11-CANADA TEL: 438-3388

HEIGHT OF TOWER / HAUTEUR DE LA TOUR	10'	15'	20'	25'	30'	35'	40'	45'	50'	55'	60'	65'	70'	75'	80'
QUANTITY REQUIRED / QUANTITE REQUISE	0	0	0	0	0	0	4	4	0	0	0	0	0	0	0
ERECTION DRAWING / DESSIN DE MONTAGE	08990-SM-01	08990-SM-02	08990-SM-03	08990-SM-04	08990-SM-05	08990-SM-06	08990-SM-07	08990-SM-08	08990-SM-09	08990-SM-10	08990-SM-11	08990-SM-12	08990-SM-13	08990-SM-14	08990-SM-15

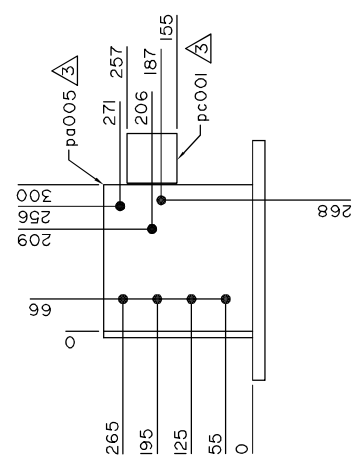
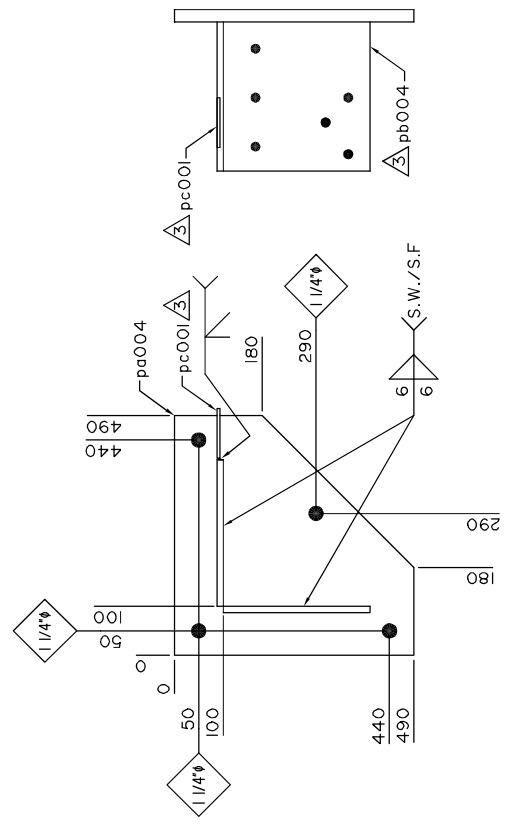

3	REVISION GENERALE (CIMA+)	2019/11/28
2	SOUUDRE REVISE	2006/02/09
1	SOUUDRE VERTICALE ENLEVE	2006/01/13
No	REVISION	DATE

Pêches et Océans
 Canada

Garde côtière
 Coast Guard

QTY	MRK	DESCRIPTION	LENGTH	GRADE	REMARK	WEIGHT	MRK	DESCRIPTION	LENGTH	GRADE	REMARK	WEIGHT
QT	MQE	DESCRIPTION	LONG.	NUANCE	REMARQUE	MASSE	MQE	DESCRIPTION	LONG.	NUANCE	REMARQUE	MASSE
1	pa004	PL 25.4 X 490	490	300W		47.9						
2	pc005	FB 12.7 X 305	300	300W	ASS. EB005	18.2						
1	pc001	PL 6.35 X 102	102	300W		0.5						

MATERIAL: G40.21M U.N. FINISH: GALV.
 HOLES: 13/16" Ø S.N. FIN.
 DRAWN: M.VACHON CHECKED: M.VACHON DATE: 2005/11/30
 DESSIN: M.VACHON VÉRIF: M.VACHON DATE: 2005/11/30
 SCALE: 1 = 10 FILE: 08990-SA DRAWING: B005
 DESSIN: M.VACHON VÉRIF: M.VACHON DATE: 2005/11/30
 DESSIN: M.VACHON VÉRIF: M.VACHON DATE: 2005/11/30



STEEL TOWERS / TOURS D'ACIER

HEIGHT OF TOWER / HAUTEUR DE LA TOUR	10'	15'	20'	25'	30'	35'	40'	45'	50'	55'	60'	65'	70'	75'	80'
QUANTITY REQUIRED / QUANTITE REQUISE	0	0	0	0	0	0	0	0	0	0	0	4	4	4	4
ERECTION DRAWING / DESSIN DE MONTAGE	08990-SM-01	08990-SM-02	08990-SM-03	08990-SM-04	08990-SM-05	08990-SM-06	08990-SM-07	08990-SM-08	08990-SM-09	08990-SM-10	08990-SM-11	08990-SM-12	08990-SM-13	08990-SM-14	08990-SM-15

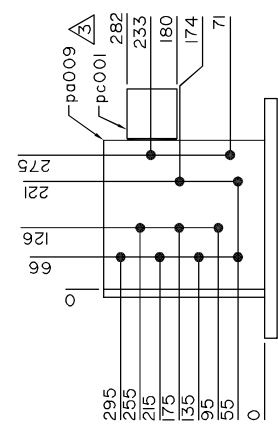
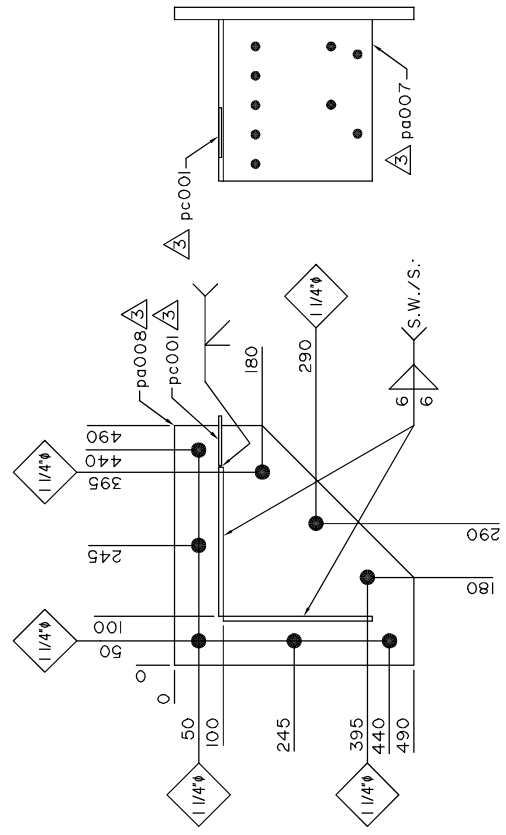

No	REVISION	DATE
3	REVISION GENERALE (CIMA+)	2019/11/28
2	SOUJURE REVISE	2006/02/09
1	SOUJURE VERTICALE ENLEVE	2006/01/13

Pêches et Océans
 Canada
 Gardie côtière
 Coast Guard

QTY	MRK	DESCRIPTION	LENGTH	GRADE	REMARK	WEIGHT
QT	MQE	DESCRIPTION	LONG.	NUANCE	REMARQUE	MASSE
1	pa008	PL 25.4 X 490	490	300W		47.9
2	pc009	FB 15.9 X 305	330	300W	ASS. EB009	25.1
1	pc001	PL 6.35 X 102	102	300W		0.5

STEEL TOWERS / TOURS D'ACIER
 MATERIAL: G40.21M U.N. FINISH: GALV.
 HOLES: 13/16" φ S.N. FIN.
 DRAWN: M.VACHON CHECKED: M.VACHON DATE: 2005/11/30
 DESSIN: M.VACHON VÉRIF: M.VACHON DATE: 2005/11/30
 SCALE: 1 = 10 FILE: 08990-SA DRAWING: BO09/3
 DOSSIER: 08990-SA DESSIN: BO09/3

QTY	MRK	DESCRIPTION	LENGTH	GRADE	REMARK	WEIGHT
QT	MQE	DESCRIPTION	LONG.	NUANCE	REMARQUE	MASSE
1	pa008	PL 25.4 X 490	490	300W		47.9
2	pc009	FB 15.9 X 305	330	300W	ASS. EB009	25.1
1	pc001	PL 6.35 X 102	102	300W		0.5

HEIGHT OF TOWER / HAUTEUR DE LA TOUR	10'	15'	20'	25'	30'	35'	40'	45'	50'	55'	60'	65'	70'	75'	80'
QUANTITY REQUIRED / QUANTITÉ REQUISE	4	4	4	4	4	4	4	4	4	4	4	4	4	4	4
ERECTION DRAWING / DESSIN DE MONTAGE	08990-SM-01	08990-SM-02	08990-SM-03	08990-SM-04	08990-SM-05	08990-SM-06	08990-SM-07	08990-SM-08	08990-SM-09	08990-SM-10	08990-SM-11	08990-SM-12	08990-SM-13	08990-SM-14	08990-SM-15

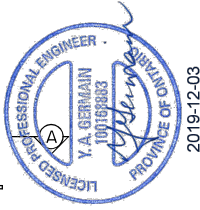
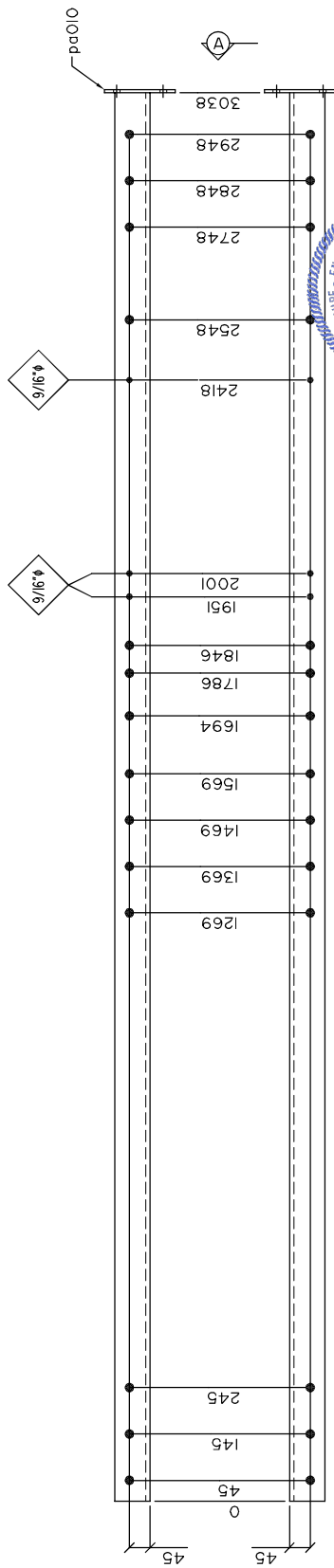

No	CONFORME A CSA S37-18 (CIMA+)	2019/11/28
REVISION		DATE
Pêches et Océans Canada		
Garde côtière Coast Guard		



STEEL TOWERS / TOURS D'ACIER	
MATERIAL / MATÉRIEL	G40.21M
UN. FINISH / S.N. FINI	13/16"Ø
DATE: 2005/12/01	
CHECKED / VÉRIFIÉ	M.VACHON
FILE: 08990-SA	
DRAWING / DESSIN	VOIØ

QTY QT	MRK MQE	DESCRIPTION	LENGTH LONG.	GRADE INUANCE	REMARK REMARQUE	WEIGHT MASSE	QTY QT	MRK MQE	DESCRIPTION	LENGTH LONG.	GRADE INUANCE	REMARK REMARQUE	WEIGHT MASSE
1	OIO	L 76	76	350W		33.6							
1	poOIO	FB 6.35	X	300W	ASS. £VOIO	1.2							
WGT / MASSE: 34.8 Kg													

VUE A-A / VUE A-A

HEIGHT OF TOWER / HAUTEUR DE LA TOUR	10'	15'	20'	25'	30'	35'	40'	45'	50'	55'	60'	65'	70'	75'	80'
QUANTITY REQUIRED / QUANTITÉ REQUISE	0	4	0	4	0	0	0	0	0	0	0	0	0	0	0
ERECTION DRAWING / DESSIN DE MONTAGE	08990-SM-01	08990-SM-02	08990-SM-03	08990-SM-04	08990-SM-05	08990-SM-06	08990-SM-07	08990-SM-08	08990-SM-09	08990-SM-10	08990-SM-11	08990-SM-12	08990-SM-13	08990-SM-14	08990-SM-15

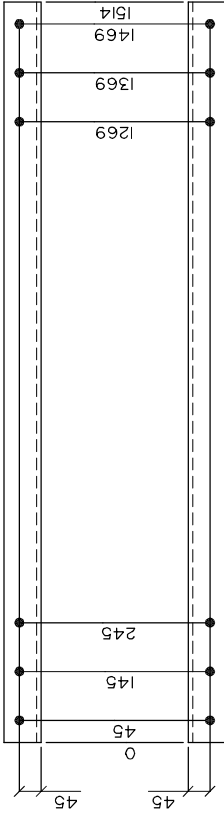

2019-12-03

2019-12-03

I	CONFORME A CSA S37-18 (CIMA+)	2019/11/28
No	REVISION	DATE
	Pêches et Océans Canada	Fisheries and Oceans Canada
	Garde côtière	Coast Guard



STEEL TOWERS / TOURS D'ACIER	
MATERIAL / MATÉRIEL	G40.21M
HOLES / TROUS	13/16"Ø
UN. / FINISH S.N. / FINI	GALV.
DRAWN / DESSINÉ	M.VACHON
CHECKED / VÉRIFIÉ	M.VACHON
DATE	2005/12/05
SCALE / ÉCHELLE	1 = 10
FILE / DOSSIER	08990-SA
DRAWING / DESSIN	VOIL

QTY	MRK	DESCRIPTION	LENGTH	GRADE	REMARK	WEIGHT	MRK	DESCRIPTION	LENGTH	GRADE	REMARK	WEIGHT
QT	MQE	DESCRIPTION	LONG.	NUANCE	REMARQUE	MASSE	MQE	DESCRIPTION	LONG.	NUANCE	REMARQUE	MASSE
1	VOIL	L 76 76	9.53	350W		16.8						

WEIGHT / MASSE: 16.8 Kg

HEIGHT OF TOWER / HAUTEUR DE LA TOUR	10'	15'	20'	25'	30'	35'	40'	45'	50'	55'	60'	65'	70'	75'	80'
QUANTITY REQUIRED / QUANTIT REQUISE	0	0	4	4	4	4	4	4	4	4	4	4	4	4	4
ERECTION DRAWING / DESSIN DE MONTAGE	08990-SM-01	08990-SM-02	08990-SM-03	08990-SM-04	08990-SM-05	08990-SM-06	08990-SM-07	08990-SM-08	08990-SM-09	08990-SM-10	08990-SM-11	08990-SM-12	08990-SM-13	08990-SM-14	08990-SM-15

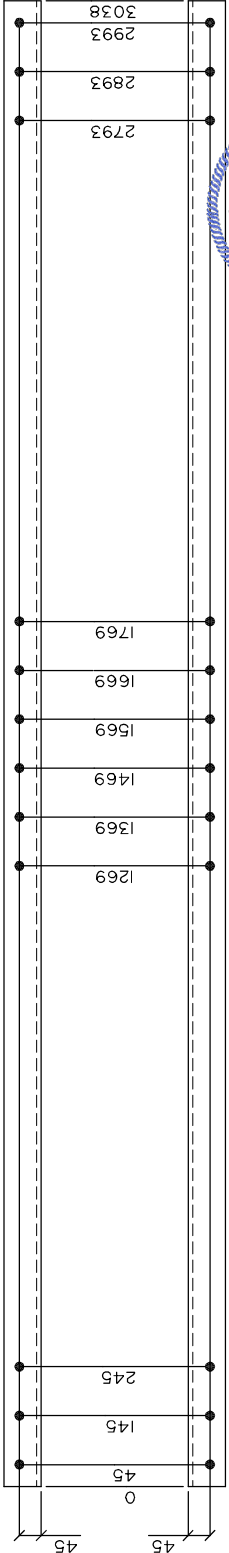

INGÉNIEUR - ENGINEER
 Yolaire Germain
 110420
 QUÉBEC
 2019-12-03

LICENSED PROFESSIONAL ENGINEER
 Y.A. BERNANN
 10719383
 PROVINCE OF ONTARIO
 2019-12-03

No	QUANTITE	REVISEE (CIMA+)	2019/11/28	DATE
I				

Pêches et Océans
 Canada
 Garde côtière
 Coast Guard

DESIGN MICHEL VACHON INC.
 DESSIN MICHEL VACHON INC.
 11-PROVINCIAL - 1100-1000

STEEL TOWERS / TOURS D'ACIER			
MATERIAL / MATÉRIEL	G40.21M	UN / FINISH	13/16"φ
DRAWN / DESSIN	M.VACHON	S.N. / FINI	GALV.
CHECKED / VÉRIFIÉ	M.VACHON	DATE	2005/12/05
SCALE / ÉCHELLE	1 = 10	FILE / DOSSIER	08990-SA
DRAWING / DESSIN			VO12

QTY	MRK	DESCRIPTION	LENGTH	GRADE	REMARK	WEIGHT	MRK	DESCRIPTION	LENGTH	GRADE	REMARK	WEIGHT
QT	MQE	DESCRIPTION	LONG.	NUANCE	REMARQUE	MASSE	MQE	DESCRIPTION	LONG.	NUANCE	REMARQUE	MASSE
I	VO12	L 76 76 9.53	3038	350W		33.6						

WEIGHT / MASSE: 33.6 Kg

HEIGHT OF TOWER / HAUTEUR DE LA TOUR	10'	15'	20'	25'	30'	35'	40'	45'	50'	55'	60'	65'	70'	75'	80'
QUANTITY REQUIRED / QUANTIT REQUISE	0	0	0	0	4	0	0	0	0	0	0	0	0	0	0
ERECTION DRAWING / DESSIN DE MONTAGE	08990-SM-01	08990-SM-02	08990-SM-03	08990-SM-04	08990-SM-05	08990-SM-06	08990-SM-07	08990-SM-08	08990-SM-09	08990-SM-10	08990-SM-11	08990-SM-12	08990-SM-13	08990-SM-14	08990-SM-15

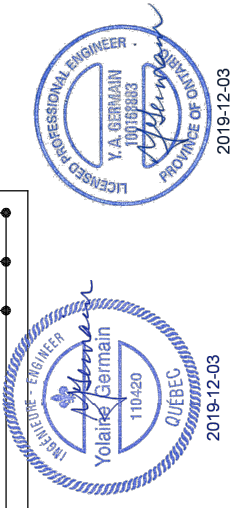
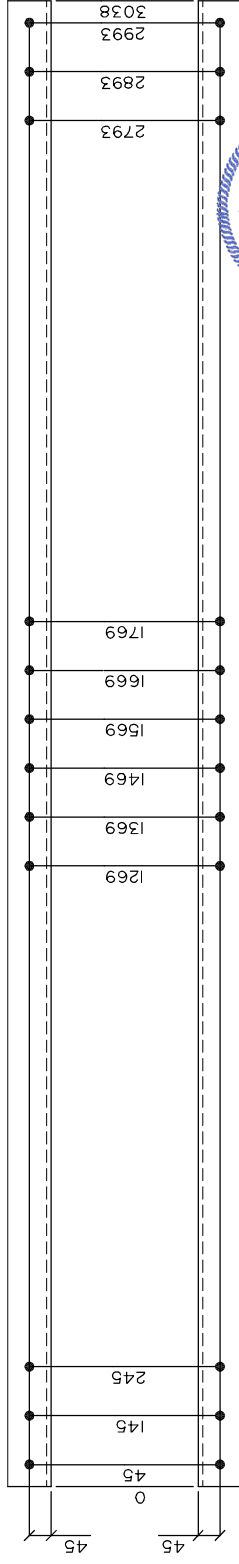

No	QUANTITE	REVISEE (CIMA+)	2019/11/28	DATE
I				

Pêches et Océans / Fisheries and Oceans
 Canada
 Garde côtière / Coast Guard

QTY	MRK	DESCRIPTION	LENGTH	GRADE	REMARK	WEIGHT
QT	MQE	DESCRIPTION	LONG.	NUANCE	REMARQUE	MASSE
I	V013	L 89 89 9.53	3038	350W		39.6

STEEL TOWERS / TOURS D'ACIER
 UN. FINISH: GALV.
 S.N. FINI: 2005/12/05
 M.VACHON / M.VACHON
 DATE: 2005/12/05
 FILE: 08990-SA
 DOSSIER: 08990-SA
 DRAWING: V013
 DESSIN: V013

QTY	MRK	DESCRIPTION	LENGTH	GRADE	REMARK	WEIGHT
QT	MQE	DESCRIPTION	LONG.	NUANCE	REMARQUE	MASSE
I	V013	L 89 89 9.53	3038	350W		39.6

WEIGHT / MASSE: 39.6 Kg
 UN. FINISH: GALV.
 S.N. FINI: 2005/12/05
 M.VACHON / M.VACHON
 DATE: 2005/12/05
 FILE: 08990-SA
 DOSSIER: 08990-SA
 DRAWING: V013
 DESSIN: V013

HEIGHT OF TOWER / HAUTEUR DE LA TOUR	10'	15'	20'	25'	30'	35'	40'	45'	50'	55'	60'	65'	70'	75'	80'
QUANTITY REQUIRED / QUANTITÉ REQUISE	0	0	0	0	0	4	0	0	0	0	0	0	0	0	0
ERECTION DRAWING / DESSIN DE MONTAGE	08990-SM-01	08990-SM-02	08990-SM-03	08990-SM-04	08990-SM-05	08990-SM-06	08990-SM-07	08990-SM-08	08990-SM-09	08990-SM-10	08990-SM-11	08990-SM-12	08990-SM-13	08990-SM-14	08990-SM-15

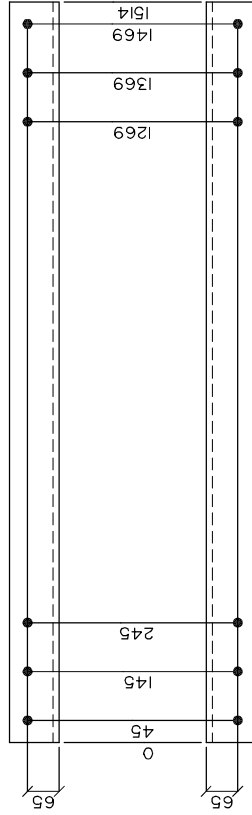

I	CONFORME A CSA S37-18 (CIMA+)	2019/11/28
No	REVISION	DATE
	Pêches et Océans Canada Gardie côtière Coast Guard	Fisheries and Oceans Canada Coast Guard

DESSIN MICHEL VACHON INC. DESSIN DES STRUCTURES EN ACIER 1100, rue de la Vallée, Québec, Québec H2V 1K6 Tél: (514) 382-7900	
STEEL TOWERS / TOURS D'ACIER	
MATERIAL / MATÉRIEL	G40.21M
HOLES / TROUS	13/16" Ø
UN. / FINISH	S.N. FINI
DATE:	2005/12/05
DRAWN / VÉRIFIÉ	M.VACHON
CHECKED:	M.VACHON
FILE / DOSSIER:	08990-SA
SCALE:	1 = 10
DRAWING:	V014
DESSIN:	V014

QTY	MRK	DESCRIPTION	LENGTH	GRADE	REMARK	WEIGHT	MRK	DESCRIPTION	LENGTH	GRADE	REMARK	WEIGHT
QT	MQE	DESCRIPTION	LONG.	NUANCE	REMARQUE	MASSE	MQE	DESCRIPTION	LONG.	NUANCE	REMARQUE	MASSE
1	V014	L 102 102	12.7	350W		29.9						

WEIGHT / MASSE: 29.9 Kg

HEIGHT OF TOWER / HAUTEUR DE LA TOUR	10'	15'	20'	25'	30'	35'	40'	45'	50'	55'	60'	65'	70'	75'	80'
QUANTITY REQUIRED / QUANTITÉ REQUISE	0	0	0	0	0	4	4	4	4	4	4	4	4	4	4
ERECTION DRAWING / DESSIN DE MONTAGE	08990-SM-01	08990-SM-02	08990-SM-03	08990-SM-04	08990-SM-05	08990-SM-06	08990-SM-07	08990-SM-08	08990-SM-09	08990-SM-10	08990-SM-11	08990-SM-12	08990-SM-13	08990-SM-14	08990-SM-15

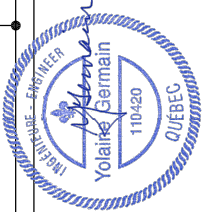
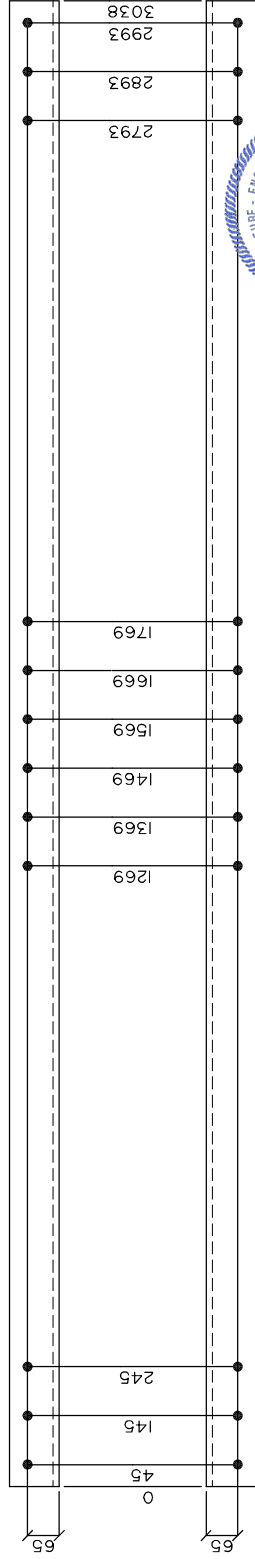

2019-12-03

2019-12-03

No	QUANTITE	REVISEE (CIMA+)	2019/11/28	DATE
I				

Pêches et Océans
 Canada
 Garde côtière
 Coast Guard



STEEL TOWERS / TOURS D'ACIER	
MATERIAL / MATÉRIEL	G40.21M
UN. / FINISH	13/16"φ
S.N. / FINI	GALV.
CHECKED / VÉRIFIÉ	M.VACHON
DATE	2005/12/05
FILE / DOSSIER	08990-SA
DRAWING / DESSIN	VO15

QTY	MRK	DESCRIPTION	LENGTH	GRADE	REMARK	WEIGHT	MRK	DESCRIPTION	LENGTH	GRADE	REMARK	WEIGHT
QT	MQE	DESCRIPTION	LONG.	NUANCE	REMARQUE	MASSE	MQE	DESCRIPTION	LONG.	NUANCE	REMARQUE	MASSE
I	VO15	L 102 102	12.7	350W		60.0						

WEIGHT / MASSE: 60.0 Kg

HEIGHT OF TOWER / HAUTEUR DE LA TOUR	10'	15'	20'	25'	30'	35'	40'	45'	50'	55'	60'	65'	70'	75'	80'
QUANTITY REQUIRED / QUANTITÉ REQUISE	0	0	0	0	0	0	0	4	0	4	0	0	0	0	0
ERECTION DRAWING / DESSIN DE MONTAGE	08990-SM-01	08990-SM-02	08990-SM-03	08990-SM-04	08990-SM-05	08990-SM-06	08990-SM-07	08990-SM-08	08990-SM-09	08990-SM-10	08990-SM-11	08990-SM-12	08990-SM-13	08990-SM-14	08990-SM-15

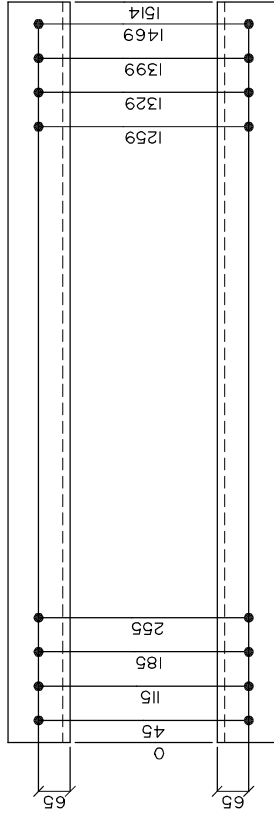

I	CONFORME A CSA S37-18 (CIMA+)	2019/11/28
No	REVISION	DATE
	Pêches et Océans Canada Gardie côtière Coast Guard	Fisheries and Oceans Canada Coast Guard

DESSIN MICHEL VACHON INC. DESSIN DES STRUCTURES EN ACIER 1100, rue de la Vallée, Québec, Québec H2V 1K6 Tél: (514) 382-7900	
STEEL TOWERS / TOURS D'ACIER	
MATERIAL / MATÉRIEL	G40.21M
HOLES / TROUS	13/16"Ø
UN. FINISH / S.N. FINI	GALV.
DRAWN / DESSINÉ	M.VACHON
CHECKED / VÉRIFIÉ	M.VACHON
DATE	2005/12/05
SCALE / ÉCHELLE	1 = 10
FILE / DOSSIER	08990-SA
DRAWING / DESSIN	VO16

QTY	MRK	DESCRIPTION	LENGTH	GRADE	REMARK	WEIGHT	MRK	DESCRIPTION	LENGTH	GRADE	REMARK	WEIGHT
QT	MQE	DESCRIPTION	LONG.	NUANCE	REMARQUE	MASSE	MQE	DESCRIPTION	LONG.	NUANCE	REMARQUE	MASSE
1	VO16	L 127 127	15.9	350W		46.7						

HEIGHT OF TOWER / HAUTEUR DE LA TOUR	10'	15'	20'	25'	30'	35'	40'	45'	50'	55'	60'	65'	70'	75'	80'
QUANTITY REQUIRED / QUANTITE REQUISE	0	0	0	0	0	0	4	4	8	8	8	0	0	0	0
ERECTION DRAWING / DESSIN DE MONTAGE	08990-SM-01	08990-SM-02	08990-SM-03	08990-SM-04	08990-SM-05	08990-SM-06	08990-SM-07	08990-SM-08	08990-SM-09	08990-SM-10	08990-SM-11	08990-SM-12	08990-SM-13	08990-SM-14	08990-SM-15

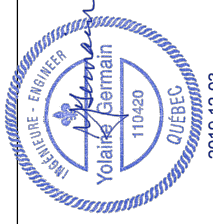
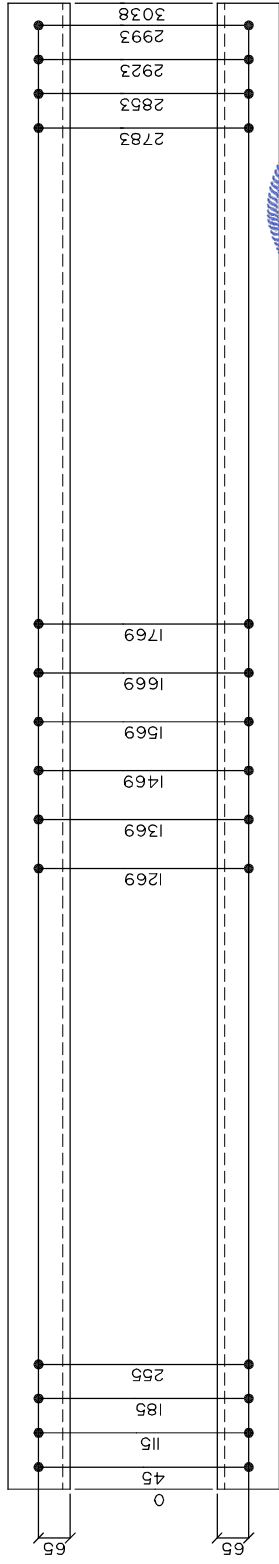

2019-12-03

No	QUANTITE	REVISEE (CIMA+)	2019/11/28	DATE
I				

Pêches et Océans
 Canada
 Gardes côtière
 Coast Guard

QTY	MRK	DESCRIPTION	LENGTH	GRADE	REMARK	WEIGHT	WGT /	WEIGHT
QT	MQE	DESCRIPTION	LONG.	NUANCE	REMARQUE	MASSE	MASSE	MASSE
I	V017	L 127 127 15.9	3038	350W		93.7	93.7	Kg

STEEL TOWERS / TOURS D'ACIER
 UN. FINISH: GALV.
 S.N. FINI: 2005/12/05
 HOLE: 13/16" Ø
 TROUS: M.VACHON
 CHECKED: M.VACHON
 DATE: 2005/12/05
 DRAWN: M.VACHON
 VERIF: M.VACHON
 FILE: 08990-SA
 DOSSIER: V017
 SCALE: 1 = 10
 DRAWING: V017
 DESSIN: V017

QTY	MRK	DESCRIPTION	LENGTH	GRADE	REMARK	WEIGHT	WGT /	WEIGHT
QT	MQE	DESCRIPTION	LONG.	NUANCE	REMARQUE	MASSE	MASSE	MASSE
I	V017	L 127 127 15.9	3038	350W		93.7	93.7	Kg

DESSIN MICHEL VACHON INC.
 DESSIN DES STRUCTURES METALLIQUES
 1100, rue de la Vallée
 1^e Étage, Québec, Québec G1R 5K6

HEIGHT OF TOWER / HAUTEUR DE LA TOUR	10'	15'	20'	25'	30'	35'	40'	45'	50'	55'	60'	65'	70'	75'	80'
QUANTITY REQUIRED / QUANTITÉ REQUISE	0	0	0	0	0	0	0	0	0	0	0	4	8	8	8
ERECTION DRAWING / DESSIN DE MONTAGE	08990-SM-01	08990-SM-02	08990-SM-03	08990-SM-04	08990-SM-05	08990-SM-06	08990-SM-07	08990-SM-08	08990-SM-09	08990-SM-10	08990-SM-11	08990-SM-12	08990-SM-13	08990-SM-14	08990-SM-15

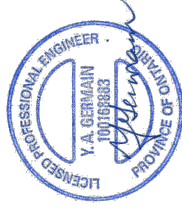
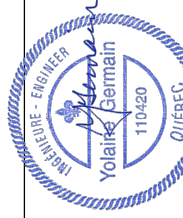
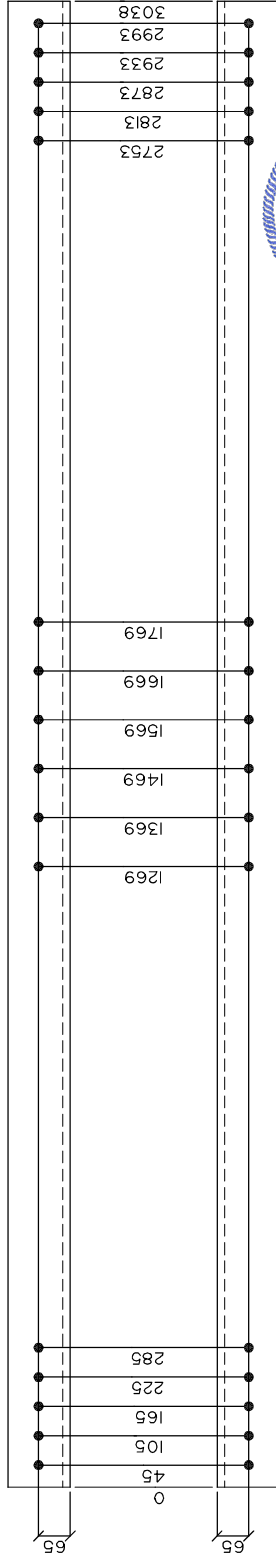

2019-12-03

2019-12-03

I	CONFORME A CSA S37-18 [CIMA+]	2019/11/28
No	REVISION	DATE
	Pêches et Océans Canada	Fisheries and Oceans Canada
	Garde côtière	Coast Guard

QTY	MRK	DESCRIPTION	LENGTH	GRADE	REMARK	WEIGHT	MRK	DESCRIPTION	LENGTH	GRADE	REMARK	WEIGHT
QT	MQE	DESCRIPTION	LONG.	NUANCE	REMARQUE	MASSE	MQE	DESCRIPTION	LONG.	NUANCE	REMARQUE	MASSE
I	VO18	L 127 127	15.9	350W		93.7						

WEIGHT / MASSE: 93.7 Kg



STEEL TOWERS / TOURS D'ACIER	
MATERIAL / MATÉRIEL	G40.21M
UN. / FINISH	13/16"φ
HOLES / TROUS	
DATE: 2005/12/05	
CHECKED: M.VACHON	
VERIFÉ: M.VACHON	
FILE: 08990-SA	
DOSSIER: 08990-SA	
DRAWING: VO18	
DESSIN: VO18	

HEIGHT OF TOWER / HAUTEUR DE LA TOUR	10'	15'	20'	25'	30'	35'	40'	45'	50'	55'	60'	65'	70'	75'	80'
QUANTITY REQUIRED / QUANTITÉ REQUISE	0	0	0	0	0	0	0	0	0	0	0	4	0	0	0
ERECTION DRAWING / DESSIN DE MONTAGE	08990-SM-01	08990-SM-02	08990-SM-03	08990-SM-04	08990-SM-05	08990-SM-06	08990-SM-07	08990-SM-08	08990-SM-09	08990-SM-10	08990-SM-11	08990-SM-12	08990-SM-13	08990-SM-14	08990-SM-15

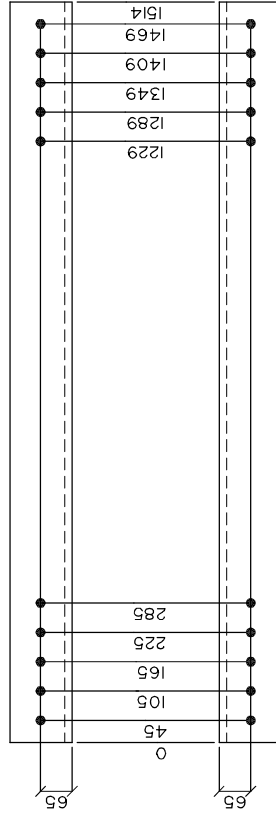

I	CONFORME A CSA S37-18 (CIMA+)	2019/11/28
No	REVISION	DATE
	Pêches et Océans Canada	Fisheries and Oceans Canada
	Garde côtière	Coast Guard

DESSIN MICHEL VAILLON INC. DESSIN DES STRUCTURES EN ACIER 1100, rue de la Vallée, Québec, Québec H2V 1K6	
STEEL TOWERS / TOURS D'ACIER	
MATERIAL / MATÉRIEL	G40.21M
UN. / FINISH S.N. / FINI	13/16"φ
HOLES / TROUS	
CHECKED / VÉRIFIÉ	M.VACHON
DATE	2005/12/05
FILE / DOSSIER	08990-SA
DRAWING / DESSIN	VO19

QTY QT	MRK MQE	DESCRIPTION	LENGTH LONG.	GRADE NUANCE	REMARK REMARQUE	WEIGHT MASSE	QTY QT	MRK MQE	DESCRIPTION	LENGTH LONG.	GRADE NUANCE	REMARK REMARQUE	WEIGHT MASSE
1	VO19	L 127 127	15.9	350W		46.7							
WEIGHT / MASSE: 46.7 Kg													

HEIGHT OF TOWER / HAUTEUR DE LA TOUR	10'	15'	20'	25'	30'	35'	40'	45'	50'	55'	60'	65'	70'	75'	80'
QUANTITY REQUIRED / QUANTIT REQUISE	0	0	0	0	0	0	0	0	0	0	0	4	0	4	0
ERECTION DRAWING / DESSIN DE MONTAGE	08990-SM-01	08990-SM-02	08990-SM-03	08990-SM-04	08990-SM-05	08990-SM-06	08990-SM-07	08990-SM-08	08990-SM-09	08990-SM-10	08990-SM-11	08990-SM-12	08990-SM-13	08990-SM-14	08990-SM-15

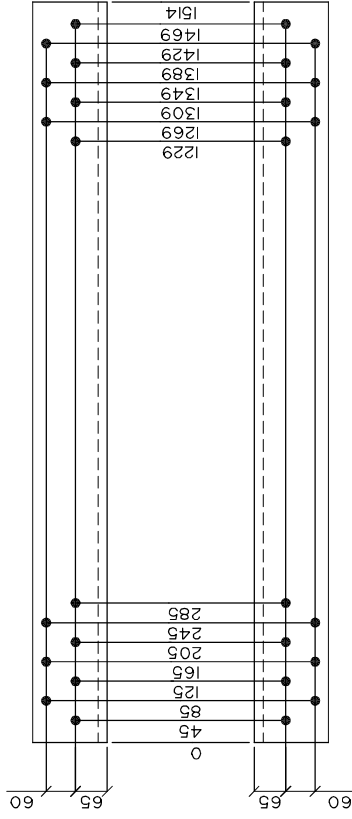

No	QUANTITE REVISEE (CIMA+)	2019/11/28
	REVISION	DATE
	Pêches et Océans Canada	Fisheries and Oceans Canada
	Garde côtière	Coast Guard

DESSIN MICHEL VACHON INC. DESSIN DES STRUCTURES EN ACIER 1100, rue de la Vallée, Québec, Québec G1M 3S8	
STEEL TOWERS / TOURS D'ACIER	
MATERIAL / MATÉRIEL	G40.21M
UN. / FINISH S.N. / FINI	13/16"φ
HOLES / TROUS	
CHECKED / VÉRIFIÉ	M.VACHON
DATE	2005/12/05
FILE / DOSSIER	08990-SA
DRAWING / DESSIN	VO21

QTY QT	MRK MQE	DESCRIPTION	LENGTH LONG.	GRADE NUANCE	REMARK REMARQUE	WEIGHT MASSE	QTY QT	MRK MQE	DESCRIPTION	LENGTH LONG.	GRADE NUANCE	REMARK REMARQUE	WEIGHT MASSE
1	VO21	L 152	19	350W		66.9							

HEIGHT OF TOWER / HAUTEUR DE LA TOUR	10'	15'	20'	25'	30'	35'	40'	45'	50'	55'	60'	65'	70'	75'	80'
QUANTITY REQUIRED / QUANTITÉ REQUISE	8	18	26	36	44	54	62	72	80	90	98	0	0	0	0
ERECTION DRAWING / DESSIN DE MONTAGE	08990-SM-01	08990-SM-02	08990-SM-03	08990-SM-04	08990-SM-05	08990-SM-06	08990-SM-07	08990-SM-08	08990-SM-09	08990-SM-10	08990-SM-11	08990-SM-12	08990-SM-13	08990-SM-14	08990-SM-15

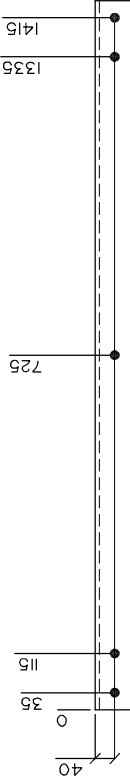

2	CONFORME A CSA S37-18 (CIMA+)	2019/11/28
1	GRADE CHANGED/NUANCE CHANGE	2006/03/22
No	REVISION	DATE

 Pêches et Océans
 Canada
 Fisheries and Oceans
 Canada

Garde côtière
Coast Guard



STEEL TOWERS / TOURS D'ACIER

MATERIAL / MATÉRIEL	G40.21M	HOLES / TROUS	13/16"Ø	U.N. / FINISH	GALV.
DRAWN / DESSINÉ	M.VACHON	CHECKED / VÉRIFIÉ	M.VACHON	DATE	2005/12/05
SCALE / ÉCHELLE	1 = 10	FILE / DOSSIER	08990-SA	DRAWING / DESSIN	X022

QTY	MRK	DESCRIPTION	LENGTH	GRADE	REMARK	WEIGHT	MRK	DESCRIPTION	LENGTH	GRADE	REMARK	WEIGHT
QT	MQE	DESCRIPTION	LONG.	NUANCE	REMARQUE	MASSE	MQE	DESCRIPTION	LONG.	NUANCE	REMARQUE	MASSE
1	X022	L 76 76	7.94	350W		12.7						

WEIGHT / MASSE: 12.7 Kg

HEIGHT OF TOWER / HAUTEUR DE LA TOUR	10'	15'	20'	25'	30'	35'	40'	45'	50'	55'	60'	65'	70'	75'	80'
QUANTITY REQUIRED / QUANTITÉ REQUISE	3	3	3	3	3	3	3	3	3	3	3	0	0	0	0
ERECTION DRAWING / DESSIN DE MONTAGE	08990-SM-01	08990-SM-02	08990-SM-03	08990-SM-04	08990-SM-05	08990-SM-06	08990-SM-07	08990-SM-08	08990-SM-09	08990-SM-10	08990-SM-11	08990-SM-12	08990-SM-13	08990-SM-14	08990-SM-15

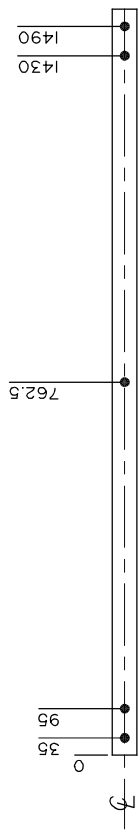

I	CONFORME A CSA S37-18 (CIMA+)	2019/11/28
No	REVISION	DATE
	Pêches et Océans Canada Gardie côtière Coast Guard	Fisheries and Oceans Canada

DESSIN MICHEL VACHON INC. DESSIN DES STRUCTURES EN ACIER 1100, rue de la Vallée, Québec, Québec G1M 3K6 Tél: (514) 382-9888	
STEEL TOWERS / TOURS D'ACIER	
MATERIAL / MATÉRIEL	G40.21M
UN. / FINISH S.N. / FINI	13/16"Ø
HOLES / TROUS	
CHECKED / VÉRIFIÉ	M.VACHON
DATE	2005/12/05
FILE / DOSSIER	08990-SA
DRAWING / DESSIN	X023

QTY	MRK	DESCRIPTION	LENGTH	GRADE	REMARK	WEIGHT	MRK	QTY	DESCRIPTION	LENGTH	GRADE	REMARK	WEIGHT
QT	MQE	DESCRIPTION	LONG.	NUANCE	REMARQUE	MASSE	MQE	QT	DESCRIPTION	LONG.	NUANCE	REMARQUE	MASSE
1	X023	FL 6.35 X 51	1525	300W		4.0							

WEIGHT / MASSE: 4.0 Kg

HEIGHT OF TOWER / HAUTEUR DE LA TOUR	10'	15'	20'	25'	30'	35'	40'	45'	50'	55'	60'	65'	70'	75'	80'
QUANTITY REQUIRED / QUANTITÉ REQUISE	0	0	0	0	0	0	0	0	0	0	0	96	104	112	120
ERECTION DRAWING / DESSIN DE MONTAGE	08990-SM-01	08990-SM-02	08990-SM-03	08990-SM-04	08990-SM-05	08990-SM-06	08990-SM-07	08990-SM-08	08990-SM-09	08990-SM-10	08990-SM-11	08990-SM-12	08990-SM-13	08990-SM-14	08990-SM-15

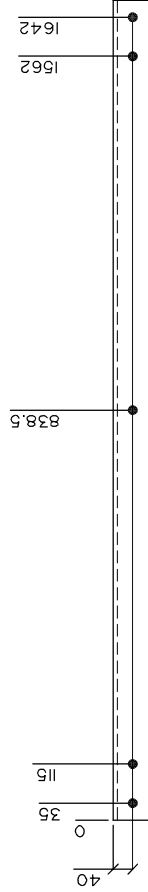

2	CONFORME A CSA S37-18 (CIMA+)	2019/11/28
1	GRADE CHANGED/NUANCE CHANGE	2006/03/22
No	REVISION	DATE

 Pêches et Océans
 Canada

Gardie côtière
 Coast Guard



DESSIN MICHEL VACHON INC.
 DESSIN DES STRUCTURES EN ACIER
 1100, rue de la Vallée
 St-Jovite, Québec J0E 1S0-7000

QTY	MRK	DESCRIPTION	LENGTH	GRADE	REMARK	WEIGHT	MRK	DESCRIPTION	LENGTH	GRADE	REMARK	WEIGHT
QT	MQE	DESCRIPTION	LONG.	NUANCE	REMARQUE	MASSE	MQE	DESCRIPTION	LONG.	NUANCE	REMARQUE	MASSE
1	X024	L 76 76	7.94	350W		14.7						

WEIGHT / MASSE: 14.7 Kg

STEEL TOWERS / TOURS D'ACIER

MATERIAL	G40.21M	HOLES	13/16"Ø	UN. FINISH	GALV.
MATERIEL	M.VACHON	TROUS	3/4"	S.N. FINI	
DRAWN	M.VACHON	CHECKED	M.VACHON	DATE	2005/12/05
DESIGN		VERIFIED		DATE	
SCALE	1 = 10	FILE	08990-SA	DRAWING	X024
		DOSSIER		DESSIN	

HEIGHT OF TOWER / HAUTEUR DE LA TOUR	10'	15'	20'	25'	30'	35'	40'	45'	50'	55'	60'	65'	70'	75'	80'
QUANTITY REQUIRED / QUANTITÉ REQUISE	3	3	3	3	3	3	3	3	3	3	3	0	0	0	0
ERECTION DRAWING / DESSIN DE MONTAGE	08990-SM-01	08990-SM-02	08990-SM-03	08990-SM-04	08990-SM-05	08990-SM-06	08990-SM-07	08990-SM-08	08990-SM-09	08990-SM-10	08990-SM-11	08990-SM-12	08990-SM-13	08990-SM-14	08990-SM-15

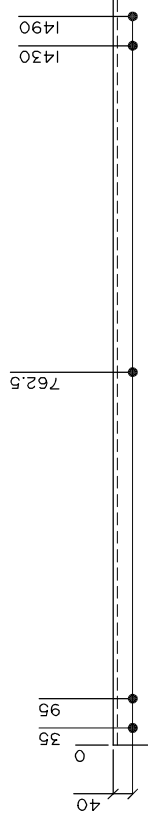

2	CONFORME A CSA S37-18 (CIMA+)	2019/11/28
1	GRADE CHANGED/NUANCE CHANGE	2006/03/22
No	REVISION	DATE
	Pêches et Océans Canada	Fisheries and Oceans Canada
	Garde côtière	Coast Guard

DESSIN MICHEL VAILLON INC. DESSIN DES STRUCTURES EN ACIER 1100, rue de la Vallée, Québec, Québec H2K 1P6	
STEEL TOWERS / TOURS D'ACIER	
MATERIAL / MATÉRIEL	G40.21M
HOLES / TROUS	13/16"Ø
UN. / FINISH	S.N. FINI
DRAWN / DESSINÉ	M.VACHON
CHECKED / VÉRIFIÉ	M.VACHON
DATE	2005/12/05
SCALE / ÉCHELLE	1 = 10
FILE / DOSSIER	08990-SA
DRAWING / DESSIN	X027

QTY	MRK	DESCRIPTION	LENGTH	GRADE	REMARK	WEIGHT	WEIGHT
QT	MQE	DESCRIPTION	LONG.	NUANCE	REMARQUE	MASSE	MASSE
1	X027	L 76 76 7.94	1525	350W		13.4	

WEIGHT / MASSE: 13.4 Kg

HEIGHT OF TOWER / HAUTEUR DE LA TOUR	10'	15'	20'	25'	30'	35'	40'	45'	50'	55'	60'	65'	70'	75'	80'
QUANTITY REQUIRED / QUANTITÉ REQUISE	0	0	0	0	0	0	0	0	0	0	0	3	3	3	3
ERECTION DRAWING / DESSIN DE MONTAGE	08990-SM-01	08990-SM-02	08990-SM-03	08990-SM-04	08990-SM-05	08990-SM-06	08990-SM-07	08990-SM-08	08990-SM-09	08990-SM-10	08990-SM-11	08990-SM-12	08990-SM-13	08990-SM-14	08990-SM-15

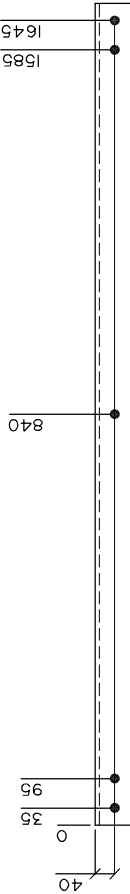

2	CONFORME A CSA S37-18 (CIMA+)	2019/11/28
1	GRADE CHANGED/NUANCE CHANGE	2006/03/22
No	REVISION	DATE

Pêches et Océans
 Canada
 Gardie côtière
 Coast Guard



STEEL TOWERS / TOURS D'ACIER	
MATERIAL / MATÉRIEL	G40.21M
HOLES / TROUS	13/16"Ø
UN. / FINISH S.N. / FINI	GALV.
DRAWN / VÉRIFIÉ	M.VACHON
CHECKED / DATE	2005/12/05
SCALE / ÉCHELLE	1 = 10
FILE / DOSSIER	08990-SA
DRAWING / DESSIN	X028

QTY	MRK	DESCRIPTION	LENGTH	GRADE	REMARK	WEIGHT	MRK	DESCRIPTION	LENGTH	GRADE	REMARK	WEIGHT
QT	MQE	DESCRIPTION	LONG.	NUANCE	REMARQUE	MASSE	MQE	DESCRIPTION	LONG.	NUANCE	REMARQUE	MASSE
1	X028	L 76 76	1680	350W		14.8						

WEIGHT / MASSE: 14.8 Kg

HEIGHT OF TOWER / HAUTEUR DE LA TOUR	10'	15'	20'	25'	30'	35'	40'	45'	50'	55'	60'	65'	70'	75'	80'
QUANTITY REQUIRED / QUANTITÉ REQUISE	3	6	9	12	15	18	21	24	27	30	33	0	0	0	0
ERECTION DRAWING / DESSIN DE MONTAGE	08990-SM-01	08990-SM-02	08990-SM-03	08990-SM-04	08990-SM-05	08990-SM-06	08990-SM-07	08990-SM-08	08990-SM-09	08990-SM-10	08990-SM-11	08990-SM-12	08990-SM-13	08990-SM-14	08990-SM-15

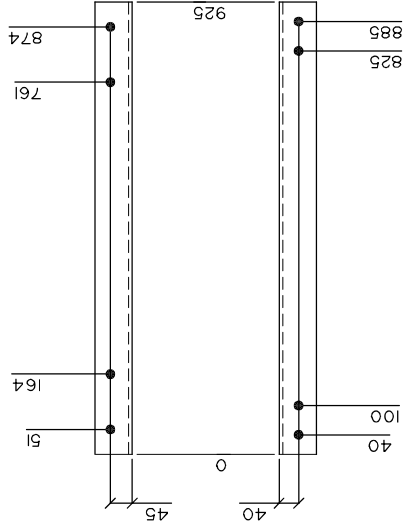

2019-12-03

2	CONFORME A CSA S37-18 (CIMA+)	2019/11/28
1	GRADE CHANGED/NUANCE CHANGE	2006/03/22
No	REVISION	DATE

Pêches et Océans
Canada

Garde côtière
Coast Guard



STEEL TOWERS / TOURS D'ACIER

MATERIAL / MATÉRIEL	G40.21M	HOLES / TROUS	13/16"Ø	U.N. / FINISH	GALV.
DRAWN / DESSINÉ	M.VACHON	CHECKED / VÉRIFIÉ	M.VACHON	DATE	2005/12/06
SCALE / ÉCHELLE	1 = 10	FILE / DOSSIER	08990-SA	DRAWING / DESSIN	H029

QTY	MRK	DESCRIPTION	LENGTH	GRADE	REMARK	WEIGHT	REMARK	LENGTH	GRADE	REMARK	WEIGHT
QT	MQE	DESCRIPTION	LONG.	NUANCE	REMARQUE	MASSE	REMARQUE	LONG.	NUANCE	REMARQUE	MASSE
1	H029	L 76 76	7.94	350W		8.1					

HEIGHT OF TOWER / HAUTEUR DE LA TOUR	10'	15'	20'	25'	30'	35'	40'	45'	50'	55'	60'	65'	70'	75'	80'
QUANTITY REQUIRED / QUANTITÉ REQUISE	1	1	1	1	1	1	1	1	1	1	1	1	1	1	1
ERECTION DRAWING / DESSIN DE MONTAGE	08990-SM-01	08990-SM-02	08990-SM-03	08990-SM-04	08990-SM-05	08990-SM-06	08990-SM-07	08990-SM-08	08990-SM-09	08990-SM-10	08990-SM-11	08990-SM-12	08990-SM-13	08990-SM-14	08990-SM-15

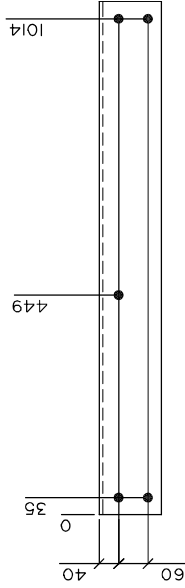

2019-12-03

2	CONFORME A CSA S37-18 (CIMA+)	2019/11/28
1	GRADE CHANGED/NUANCE CHANGE	2006/03/22
No	REVISION	DATE



Pêches et Océans
Canada

Garde côtière
Coast Guard



DESSIN MICHEL VAILLON INC.
DESSIN DES STRUCTURES EN ACIER
1100, rue de la Vallée
St-Jovite, Québec J0E 1S0-1P0

STEEL TOWERS / TOURS D'ACIER	
MATERIAL / MATÉRIEL	G40.21M
UN. / FINISH S.N. / FINI	13/16"Ø
HOLES / TROUS	
CHECKED / VÉRIFIÉ	M. VACHON
DATE	2005/12/06
FILE / DOSSIER	08990-SA
DRAWING / DESSIN	H031
SCALE	1 = 10

QTY	MRK	DESCRIPTION	LENGTH	GRADE	REMARK	WEIGHT	MRK	DESCRIPTION	LENGTH	GRADE	REMARK	WEIGHT
QT	MQE	DESCRIPTION	LONG.	NUANCE	REMARQUE	MASSE	MQE	DESCRIPTION	LONG.	NUANCE	REMARQUE	MASSE
1	H031	L 127 127	7.94	350W		16.6						

WEIGHT / MASSE: 16.6 Kg

HEIGHT OF TOWER / HAUTEUR DE LA TOUR	10'	15'	20'	25'	30'	35'	40'	45'	50'	55'	60'	65'	70'	75'	80'
QUANTITY REQUIRED / QUANTITÉ REQUISE	3	3	3	3	3	3	3	3	3	3	3	3	3	3	3
ERECTION DRAWING / DESSIN DE MONTAGE	08990-SM-01	08990-SM-02	08990-SM-03	08990-SM-04	08990-SM-05	08990-SM-06	08990-SM-07	08990-SM-08	08990-SM-09	08990-SM-10	08990-SM-11	08990-SM-12	08990-SM-13	08990-SM-14	08990-SM-15

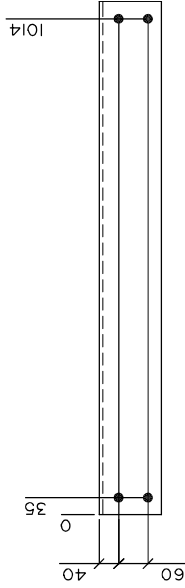

2019-12-03

2	CONFORME A CSA S37-18 (CIMA+)	2019/11/28
1	GRADE CHANGED/NUANCE CHANGE	2006/03/22
No	REVISION	DATE



Pêches et Océans
Canada

Garde côtière
Coast Guard



DESSIN MICHEL VAILLON INC.
DESSIN DES STRUCTURES EN ACIER
1100, rue de la Vallée
St-Jovite, Québec J0E 1S0-7000

QTY	MRK	DESCRIPTION	LENGTH	GRADE	REMARK	WEIGHT	MRK	DESCRIPTION	LENGTH	GRADE	REMARK	WEIGHT
QT	MQE	DESCRIPTION	LONG.	NUANCE	REMARQUE	MASSE	MQE	DESCRIPTION	LONG.	NUANCE	REMARQUE	MASSE
1	H032	L 127 127 7.94	1049	350W		16.6						

WEIGHT / MASSE: 16.6 Kg

STEEL TOWERS / TOURS D'ACIER	
MATERIAL / MATÉRIEL	G40.21M
UN. FINISH / S.N. FINI	13/16"Ø
DATE: 2005/12/06	
CHECKED / VÉRIFIÉ	M. VACHON
FILE: 08990-SA	
DRAWING: H032	
DOSSIER: H032	

HEIGHT OF TOWER / HAUTEUR DE LA TOUR	10'	15'	20'	25'	30'	35'	40'	45'	50'	55'	60'	65'	70'	75'	80'
QUANTITY REQUIRED / QUANTIT REQUISE	1	1	1	1	1	1	1	1	1	1	1	0	0	0	0
ERECTION DRAWING / DESSIN DE MONTAGE	08990-SM-01	08990-SM-02	08990-SM-03	08990-SM-04	08990-SM-05	08990-SM-06	08990-SM-07	08990-SM-08	08990-SM-09	08990-SM-10	08990-SM-11	08990-SM-12	08990-SM-13	08990-SM-14	08990-SM-15

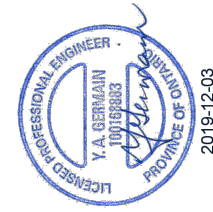
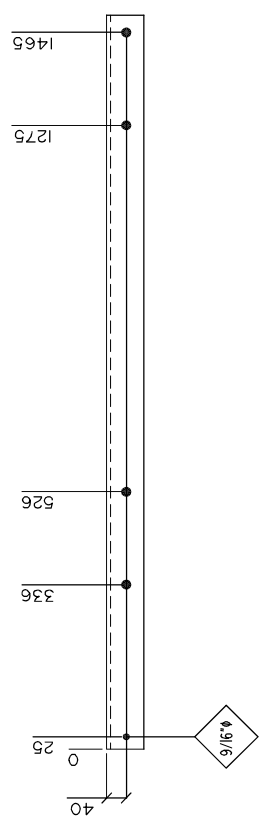

3	CONFORME A CSA S37-18 (CIMA+)	2019/11/28
2	GRADE CHANGED/NUANCE CHANGE	2006/03/22
1	NOUVELLE DESIGNATION	2006/01/19
No	REVISION	DATE

Pêches et Océans
 Canada
 Gardie côtière
 Coast Guard



STEEL TOWERS / TOURS D'ACIER
 MATERIAL / MATÉRIEL: G40.21M / TROUS: 13/16"Ø UN / FINISH: GALV.
 DRAWN / DESSIN: M.VACHON / VÉRIF: M.VACHON DATE: 2005/12/06
 SCALE: 1 = 10 FILE: 08990-SA DRAWING: P035

QTY	MRK	DESCRIPTION	LENGTH	GRADE	REMARK	WEIGHT	DESCRIPTION	LENGTH	GRADE	REMARK	WEIGHT
QT	MQE	DESCRIPTION	LONG.	NUANCE	REMARQUE	MASSE	DESCRIPTION	LONG.	NUANCE	REMARQUE	MASSE
1	P035	L 76 76	7.94	350W		14.1					

WEIGHT / MASSE: 14.1 KG

HEIGHT OF TOWER / HAUTEUR DE LA TOUR	10'	15'	20'	25'	30'	35'	40'	45'	50'	55'	60'	65'	70'	75'	80'
QUANTITY REQUIRED / QUANTITÉ REQUISE	0	0	0	0	0	0	0	0	0	0	0	0	0	0	0
ERECTION DRAWING / DESSIN DE MONTAGE	08990-SM-01	08990-SM-02	08990-SM-03	08990-SM-04	08990-SM-05	08990-SM-06	08990-SM-07	08990-SM-08	08990-SM-09	08990-SM-10	08990-SM-11	08990-SM-12	08990-SM-13	08990-SM-14	08990-SM-15

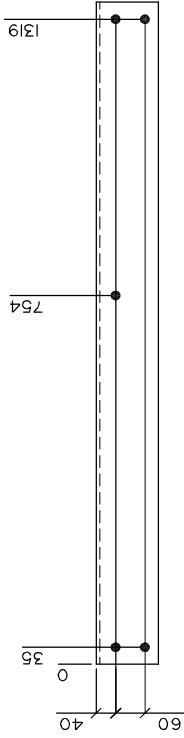

2019-12-03

2	CONFORME A CSA S37-18 (CIMA+)	2019/11/28
1	GRADE CHANGED/NUANCE CHANGE	2006/03/22
No	REVISION	DATE

Pêches et Océans
Canada

Garde côtière
Coast Guard



STEEL TOWERS / TOURS D'ACIER	
MATERIAL / MATÉRIEL	G40.21M
HOLES / TROUS	13/16" Ø
UN. FINISH / S.N. FINI	GALV.
DRAWN / DESSINÉ	M. VACHON
CHECKED / VÉRIFIÉ	M. VACHON
DATE	2005/12/06
SCALE / ÉCHELLE	1 = 10
FILE / DOSSIER	08990-SA
DRAWING / DESSIN	H039

QTY	MRK	DESCRIPTION	LENGTH	GRADE	REMARK	WEIGHT	MRK	DESCRIPTION	LENGTH	GRADE	REMARK	WEIGHT
QT	MQE	DESCRIPTION	LONG.	NUANCE	REMARQUE	MASSE	MQE	DESCRIPTION	LONG.	NUANCE	REMARQUE	MASSE
1	H039	L 127	1354	350W		21.4						

WEIGHT / MASSE: 21.4 Kg

HEIGHT OF TOWER / HAUTEUR DE LA TOUR	10'	15'	20'	25'	30'	35'	40'	45'	50'	55'	60'	65'	70'	75'	80'
QUANTITY REQUIRED / QUANTITÉ REQUISE	0	0	0	0	0	0	0	0	0	0	0	3	3	3	3
ERECTION DRAWING / DESSIN DE MONTAGE	08990-SM-01	08990-SM-02	08990-SM-03	08990-SM-04	08990-SM-05	08990-SM-06	08990-SM-07	08990-SM-08	08990-SM-09	08990-SM-10	08990-SM-11	08990-SM-12	08990-SM-13	08990-SM-14	08990-SM-15

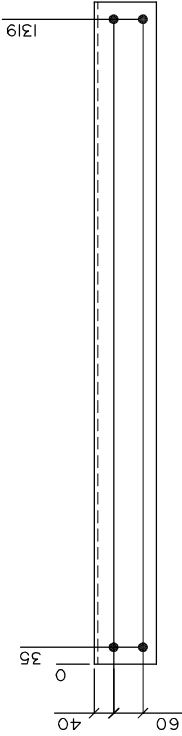

2019-12-03

2	CONFORME A CSA S37-18 (CIMA+)	2019/11/28
1	GRADE CHANGED/NUANCE CHANGE	2006/03/22
No	REVISION	DATE

Pêches et Océans
Canada

Garde côtière
Coast Guard



DESSIN MICHEL VAILLON INC.
DESSIN DES STRUCTURES EN ACIER
1100, rue de la Vallée
St-Jovite, Québec J0E 1S0-7000

STEEL TOWERS / TOURS D'ACIER	
MATERIAL / MATÉRIEL	G40.21M
HOLES / TROUS	13/16" Ø
UN. FINISH / S.N. FINI	GALV.
DRAWN / DESSINÉ	M. VACHON
CHECKED / VÉRIFIÉ	M. VACHON
DATE	2005/12/06
SCALE / ÉCHELLE	1 = 10
FILE / DOSSIER	08990-SA
DRAWING / DESSIN	H040

QTY	MRK	DESCRIPTION	LENGTH	GRADE	REMARK	WEIGHT	MRK	DESCRIPTION	LENGTH	GRADE	REMARK	WEIGHT
QT	MQE	DESCRIPTION	LONG.	NUANCE	REMARQUE	MASSE	MQE	DESCRIPTION	LONG.	NUANCE	REMARQUE	MASSE
1	H040	L 127	1354	350W		21.4						

WEIGHT / MASSE: 21.4 Kg

HEIGHT OF TOWER / HAUTEUR DE LA TOUR	10'	15'	20'	25'	30'	35'	40'	45'	50'	55'	60'	65'	70'	75'	80'
QUANTITY REQUIRED / QUANTITÉ REQUISE	0	0	0	0	0	0	0	0	0	0	0	0	0	0	0
ERECTION DRAWING / DESSIN DE MONTAGE	08990-SM-01	08990-SM-02	08990-SM-03	08990-SM-04	08990-SM-05	08990-SM-06	08990-SM-07	08990-SM-08	08990-SM-09	08990-SM-10	08990-SM-11	08990-SM-12	08990-SM-13	08990-SM-14	08990-SM-15

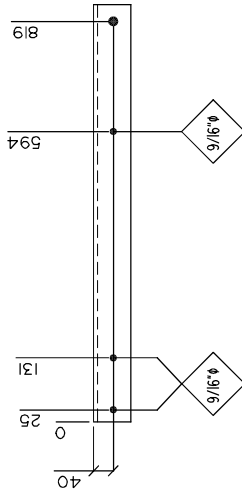

2019-12-03

2019-12-03

3	CONFORME A CSA S37-18 (CIMA+)	2019/11/28
2	GRADE CHANGED/NUANCE CHANGE	2006/03/22
1	NOUVELLE DESIGNATION	2006/01/19
No	REVISION	DATE



Pêches et Océans
Canada

Garde côtière
Coast Guard



DESSIN MICHEL VACHON INC.
DESIGN MICHEL VACHON INC.
1100 BOULEVARD DES ÉTOILES, 11^E FLOURE
MONTREAL, QUEBEC H3M 1S6-7000

STEEL TOWERS / TOURS D'ACIER	
MATERIAL / MATÉRIEL	G40.21M
HOLES / TROUS	13/16" Ø
UN. / FINISH	S.N. FINI
FINISH	GALV.
DRAWN / DESSINÉ	M. VACHON
CHECKED / VÉRIFIÉ	M. VACHON
DATE	2005/12/06
SCALE / ÉCHELLE	1 = 10
FILE / DOSSIER	08990-SA
DRAWING / DESSIN	P041

WEIGHT / MASSE: 8.0 Kg

QTY	MRK	DESCRIPTION	LENGTH	GRADE	REMARK	WEIGHT
QT	MQE	DESCRIPTION	LONG.	NUANCE	REMARQUE	MASSE
1	P041	L 76 76 7.94	854	350W		8.0

HEIGHT OF TOWER / HAUTEUR DE LA TOUR	10'	15'	20'	25'	30'	35'	40'	45'	50'	55'	60'	65'	70'	75'	80'
QUANTITY REQUIRED / QUANTITÉ REQUISE	0	0	0	0	0	0	0	0	0	0	0	0	0	0	0
ERECTION DRAWING / DESSIN DE MONTAGE	08990-SM-01	08990-SM-02	08990-SM-03	08990-SM-04	08990-SM-05	08990-SM-06	08990-SM-07	08990-SM-08	08990-SM-09	08990-SM-10	08990-SM-11	08990-SM-12	08990-SM-13	08990-SM-14	08990-SM-15

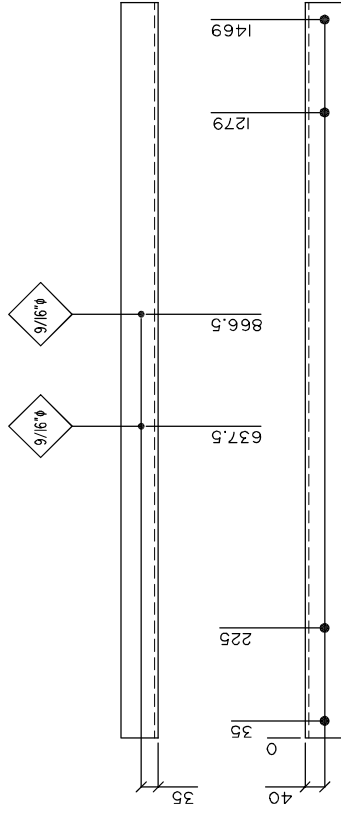

3	CONFORME A CSA S37-18 [CIMA+]	2019/11/28
2	GRADE CHANGED/NUANCE CHANGE	2006/03/22
1	NOUVELLE DESIGNATION	2006/01/19
No	REVISION	DATE

Pêches et Océans
 Canada
 Gardie côtière
 Coast Guard



STEEL TOWERS / TOURS D'ACIER	
MATERIAL / MATÉRIEL	G40.21M
UN. / FINISH S.N. / FINI	13/16"Ø
HOLES / TROUS	13/16"Ø
DRAWN / DESSINÉ	M. VACHON
CHECKED / VÉRIFIÉ	M. VACHON
DATE	2005/12/06
FILE / DOSSIER	08990-SA
DRAWING / DESSIN	P042
SCALE	1 = 10

QTY	MRK	DESCRIPTION	LENGTH	GRADE	REMARK	WEIGHT	MRK	DESCRIPTION	LENGTH	GRADE	REMARK	WEIGHT
QT	MQE	DESCRIPTION	LONG.	NUANCE	REMARQUE	MASSE	MQE	DESCRIPTION	LONG.	NUANCE	REMARQUE	MASSE
1	P042	L 76 76	7.94	1504	350W	14.2						

WEIGHT / MASSE: 14.2 Kg

HEIGHT OF TOWER / HAUTEUR DE LA TOUR	10'	15'	20'	25'	30'	35'	40'	45'	50'	55'	60'	65'	70'	75'	80'
QUANTITY REQUIRED / QUANTITÉ REQUISE	0	0	0	0	0	0	0	0	0	0	0	0	0	0	0
ERECTION DRAWING / DESSIN DE MONTAGE	08990-SM-01	08990-SM-02	08990-SM-03	08990-SM-04	08990-SM-05	08990-SM-06	08990-SM-07	08990-SM-08	08990-SM-09	08990-SM-10	08990-SM-11	08990-SM-12	08990-SM-13	08990-SM-14	08990-SM-15

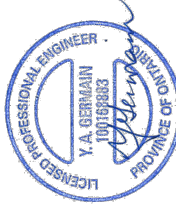
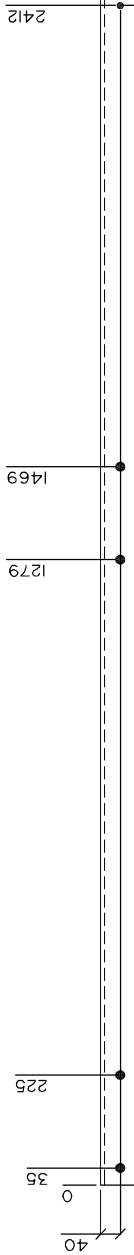

2019-12-03

2019-12-03

3	CONFORME A CSA S37-18 (CIMA+)	2019/11/28
2	GRADE CHANGED/NUANCE CHANGE	2006/03/22
1	NOUVELLE DESIGNATION	2006/01/19
No	REVISION	DATE

Pêches et Océans
Canada

Fisheries and Oceans
Canada

Garde côtière
Coast Guard



DESSIN MICHEL VACHON INC.
DESSIN DES STRUCTURES EN ACIER
11-PROVINCE, TEL: 514-354-9346
11-COAST GUARD, TEL: 514-354-9346

STEEL TOWERS / TOURS D'ACIER

MATERIAL / MATÉRIEL	G40.21M	HOLES / TROUS	13/16"Ø	UN. FINISH / S.N. FINI	GALV.
DRAWN / DESSINÉ	M.VACHON	CHECKED / VÉRIFIÉ	M.VACHON	DATE	2005/12/06
SCALE / ÉCHELLE	1 = 10	FILE / DOSSIER	08990-SA	DRAWING / DESSIN	P044

WEIGHT / MASSE: 23.0 Kg

QTY QT	MRK MQE	DESCRIPTION	LENGTH LONG.	GRADE NUANCE	REMARK REMARQUE	WEIGHT MASSE	QTY QT	MRK MQE	DESCRIPTION	LENGTH LONG.	GRADE NUANCE	REMARK REMARQUE	WEIGHT MASSE
1	P044	L 76 76	24.37	350W		23.0							

HEIGHT OF TOWER / HAUTEUR DE LA TOUR	10'	15'	20'	25'	30'	35'	40'	45'	50'	55'	60'	65'	70'	75'	80'
QUANTITY REQUIRED / QUANTIT REQUISE	1	1	1	1	1	1	1	1	1	1	1	1	1	1	1
ERECTION DRAWING / DESSIN DE MONTAGE	08990-SM-01	08990-SM-02	08990-SM-03	08990-SM-04	08990-SM-05	08990-SM-06	08990-SM-07	08990-SM-08	08990-SM-09	08990-SM-10	08990-SM-11	08990-SM-12	08990-SM-13	08990-SM-14	08990-SM-15

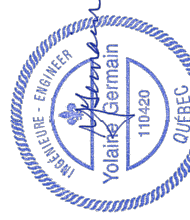
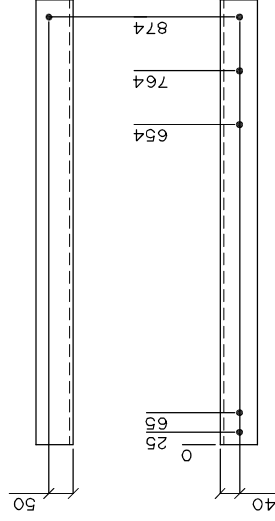

2019-12-03

2	CONFORME A CSA S37-18 (CIMA+)	2019/11/28
1	GRADE CHANGED/NUANCE CHANGE	2006/03/22
No	REVISION	DATE

Pêches et Océans
Canada

Garde côtière
Coast Guard



STEEL TOWERS / TOURS D'ACIER

MATERIAL / MATÉRIEL	G40.21M	HOLES / TROUS	9/16"φ	UN. FINISH / S.N. FINI	GALV.
DRAWN / DESSINÉ	M.VACHON	CHECKED / VÉRIFIÉ	M.VACHON	DATE	2005/12/08
SCALE / ÉCHELLE	1 = 10	FILE / DOSSIER	08990-SA	DRAWING / DESSIN	P045

WEIGHT / MASSE: 8.6 Kg

QTY QT	MRK MQE	DESCRIPTION	LENGTH LONG.	GRADE NUANCE	REMARK REMARQUE	WEIGHT MASSE	QTY QT	MRK MQE	DESCRIPTION	LENGTH LONG.	GRADE NUANCE	REMARK REMARQUE	WEIGHT MASSE
1	P045	L 76 76	909	350W		8.6							

HEIGHT OF TOWER / HAUTEUR DE LA TOUR	10'	15'	20'	25'	30'	35'	40'	45'	50'	55'	60'	65'	70'	75'	80'
QUANTITY REQUIRED / QUANTITÉ REQUISE	1	1	1	1	1	1	1	1	1	1	1	1	1	1	1
ERECTION DRAWING / DESSIN DE MONTAGE	08990-SM-01	08990-SM-02	08990-SM-03	08990-SM-04	08990-SM-05	08990-SM-06	08990-SM-07	08990-SM-08	08990-SM-09	08990-SM-10	08990-SM-11	08990-SM-12	08990-SM-13	08990-SM-14	08990-SM-15

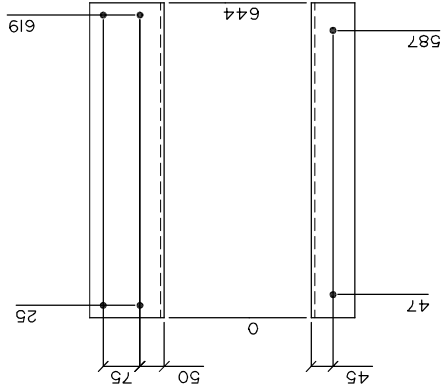

2	CONFORME A CSA S37-18 (CIMA+)	2019/11/28
1	GRADE CHANGED/NUANCE CHANGE	2006/03/22
No	REVISION	DATE

Pêches et Océans
 Canada
 Gardie côtière
 Coast Guard



STEEL TOWERS / TOURS D'ACIER
 MATERIAL: G40.21M UN. FINISH: GALV.
 MATERIEL: TROUS: 9/16"φ S.N. FINI: GALV.
 DRAWN: M.VACHON CHECKED: M.VACHON DATE: 2005/12/08
 DESSIN: VÉRIFIÉ: M.VACHON
 SCALE: 1 = 10 FILE: 08990-SA DRAWING: P046
 DOSSIER: DESSIN:

QTY	MRK	DESCRIPTION	LENGTH	GRADE	REMARK	WEIGHT	WEIGHT
QT	MQE	DESCRIPTION	LONG.	NUANCE	REMARQUE	MASSE	MASSE
1	P046	L 152 89 7.94	644	350W		9.7	9.7 Kg

HEIGHT OF TOWER / HAUTEUR DE LA TOUR	10'	15'	20'	25'	30'	35'	40'	45'	50'	55'	60'	65'	70'	75'	80'
QUANTITY REQUIRED / QUANTITÉ REQUISE	1	1	1	1	1	1	1	1	1	1	1	1	1	1	1
ERECTION DRAWING / DESSIN DE MONTAGE	08990-SM-01	08990-SM-02	08990-SM-03	08990-SM-04	08990-SM-05	08990-SM-06	08990-SM-07	08990-SM-08	08990-SM-09	08990-SM-10	08990-SM-11	08990-SM-12	08990-SM-13	08990-SM-14	08990-SM-15

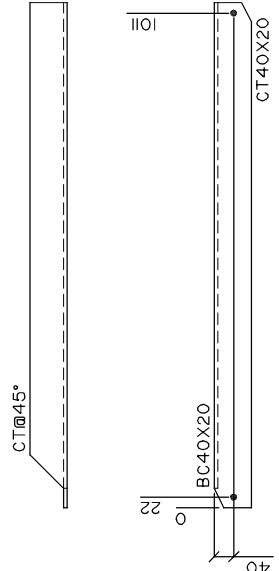

2	CONFORME A CSA S37-18 (CIMA+)	2019/11/28
1	GRADE CHANGED/NUANCE CHANGE	2006/03/22
No	REVISION	DATE

Pêches et Océans
 Canada
 Gardes côtière
 Coast Guard



STEEL TOWERS / TOURS D'ACIER
 MATERIAL: G40.21M UN. FINISH: GALV.
 MATERIEL: TROUS: 9/16"φ S.N. FINI: GALV.
 DRAWN: M.VACHON CHECKED: M.VACHON DATE: 2005/12/08
 DESSIN: VÉRIFIÉ: M.VACHON
 SCALE: 1 = 10 FILE: 08990-SA DRAWING: P048
 DOSSIER: 08990-SA DESSIN: P048

QTY	MRK	DESCRIPTION	LENGTH	GRADE	REMARK	WEIGHT	REMARK	GRADE	LENGTH	DESCRIPTION	MRK	QTY	WEIGHT	REMARK
QT	MQE	DESCRIPTION	LONG.	NUANCE	REMARQUE	MASSE	REMARQUE	NUANCE	LONG.	DESCRIPTION	MQE	QT	MASSE	REMARQUE
1	P048	L 76 76	7.94	350W	CLIP/CIS.	9.7								

WEIGHT / MASSE: 9.7 Kg

HEIGHT OF TOWER / HAUTEUR DE LA TOUR	10'	15'	20'	25'	30'	35'	40'	45'	50'	55'	60'	65'	70'	75'	80'
QUANTITY REQUIRED / QUANTITÉ REQUISE	2	2	2	2	2	2	2	2	2	2	2	2	2	2	2
ERECTION DRAWING / DESSIN DE MONTAGE	08990-SM-01	08990-SM-02	08990-SM-03	08990-SM-04	08990-SM-05	08990-SM-06	08990-SM-07	08990-SM-08	08990-SM-09	08990-SM-10	08990-SM-11	08990-SM-12	08990-SM-13	08990-SM-14	08990-SM-15

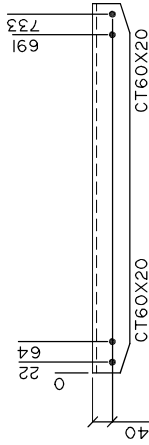

2	CONFORME A CSA S37-18 (CIMA+)	2019/11/28
1	GRADE CHANGED/NUANCE CHANGE	2006/03/22
No	REVISION	DATE

Pêches et Océans
 Canada
 Fisheries and Oceans
 Canada

Garde côtière
Coast Guard



DESSIN MICHEL VACHON INC.
 DESSIN DES STRUCTURES EN ACIER
 1100, rue de la Vallée
 St-Jovite, Québec J0E 1S0-1P00

STEEL TOWERS / TOURS D'ACIER

MATERIAL / MATÉRIEL	G40.21M	HOLES / TROUS	9/16"φ	UN. FINISH / S.N. FINI	GALV.
DRAWN / DESSINÉ	M.VACHON	CHECKED / VÉRIFIÉ	M.VACHON	DATE	2005/12/08
SCALE / ÉCHELLE	1 = 10	FILE / DOSSIER	08990-SA	DRAWING / DESSIN	P049

WEIGHT / MASSE: 7.1 Kg

QTY QT	MRK MQE	DESCRIPTION	LENGTH LONG.	GRADE NUANCE	REMARK REMARQUE	WEIGHT MASSE	QTY QT	MRK MQE	DESCRIPTION	LENGTH LONG.	GRADE NUANCE	REMARK REMARQUE	WEIGHT MASSE
1	P049	L 76 76	7.94	350W	CLIP/CIS.	7.1							

HEIGHT OF TOWER / HAUTEUR DE LA TOUR	10'	15'	20'	25'	30'	35'	40'	45'	50'	55'	60'	65'	70'	75'	80'
QUANTITY REQUIRED / QUANTITÉ REQUISE	1	1	1	1	1	1	1	1	1	1	1	1	1	1	1
ERECTION DRAWING / DESSIN DE MONTAGE	08990-SM-01	08990-SM-02	08990-SM-03	08990-SM-04	08990-SM-05	08990-SM-06	08990-SM-07	08990-SM-08	08990-SM-09	08990-SM-10	08990-SM-11	08990-SM-12	08990-SM-13	08990-SM-14	08990-SM-15

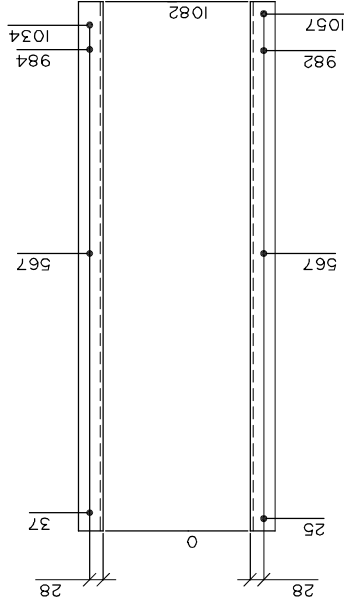

2019-12-03

2	CONFORME A CSA S37-18 (CIMA+)	2019/11/28
1	GRADE CHANGED/NUANCE CHANGE	2006/03/22
No	REVISION	DATE

 Pêches et Océans
 Canada
 Gardes côtière
 Coast Guard



STEEL TOWERS / TOURS D'ACIER	
MATERIAL / MATÉRIEL	G40.21M
HOLES / TROUS	9/16" φ
UN. FINISH / S.N. FINI	GALV.
DRAWN / DESSINÉ	M.VACHON
CHECKED / VÉRIFIÉ	M.VACHON
DATE	2005/12/08
SCALE / ÉCHELLE	1 = 10
FILE / DOSSIER	08990-SA
DRAWING / DESSIN	PO50

QTY	MRK	DESCRIPTION	LENGTH	GRADE	REMARK	WEIGHT	MRK	DESCRIPTION	LENGTH	GRADE	REMARK	WEIGHT
QT	MQE	DESCRIPTION	LONG.	NUANCE	REMARQUE	MASSE	MQE	DESCRIPTION	LONG.	NUANCE	REMARQUE	MASSE
1	PO50	L 51 6.35	1082	350W		5.3						

WEIGHT / MASSE: 5.3 Kg

HEIGHT OF TOWER / HAUTEUR DE LA TOUR	10'	15'	20'	25'	30'	35'	40'	45'	50'	55'	60'	65'	70'	75'	80'
QUANTITY REQUIRED / QUANTITÉ REQUISE	1	1	1	1	1	1	1	1	1	1	1	1	1	1	1
ERECTION DRAWING / DESSIN DE MONTAGE	08990-SM-01	08990-SM-02	08990-SM-03	08990-SM-04	08990-SM-05	08990-SM-06	08990-SM-07	08990-SM-08	08990-SM-09	08990-SM-10	08990-SM-11	08990-SM-12	08990-SM-13	08990-SM-14	08990-SM-15

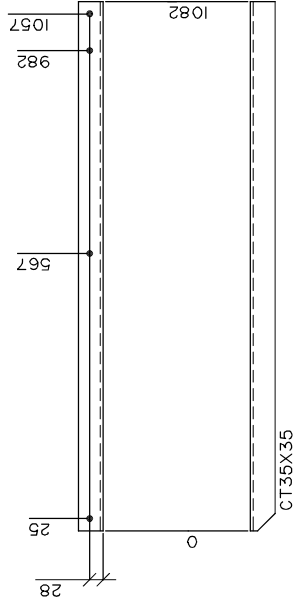

2019-12-03

2	CONFORME A CSA S37-18 (CIMA+)	2019/11/28
1	GRADE CHANGED/NUANCE CHANGE	2006/03/22
No	REVISION	DATE

Pêches et Océans
 Canada
 Gardie côtière
 Coast Guard



STEEL TOWERS / TOURS D'ACIER	
MATERIAL / MATÉRIEL	G40.21M
HOLES / TROUS	9/16"φ
UN. FINISH / S.N. FINI	GALV.
DRAWN / DESSINÉ	M.VACHON
CHECKED / VÉRIFIÉ	M.VACHON
DATE / DATE	2005/12/08
SCALE / ÉCHELLE	1 = 10
FILE / DOSSIER	08990-SA
DRAWING / DESSIN	P051

QTY	MRK	DESCRIPTION	LENGTH	GRADE	REMARK	WEIGHT	REMARK	LENGTH	GRADE	REMARK	WEIGHT
QT	MQE	DESCRIPTION	LONG.	NUANCE	REMARQUE	MASSE	REMARQUE	LONG.	NUANCE	REMARQUE	MASSE
1	P051	L 51 51 6.35	1082	350W	CLIP/CIS.	5.3					

WEIGHT / MASSE: 5.3 Kg

HEIGHT OF TOWER / HAUTEUR DE LA TOUR	10'	15'	20'	25'	30'	35'	40'	45'	50'	55'	60'	65'	70'	75'	80'
QUANTITY REQUIRED / QUANTITÉ REQUISE	1	1	1	1	1	1	1	1	1	1	1	1	1	1	1
ERECTION DRAWING / DESSIN DE MONTAGE	08990-SM-01	08990-SM-02	08990-SM-03	08990-SM-04	08990-SM-05	08990-SM-06	08990-SM-07	08990-SM-08	08990-SM-09	08990-SM-10	08990-SM-11	08990-SM-12	08990-SM-13	08990-SM-14	08990-SM-15

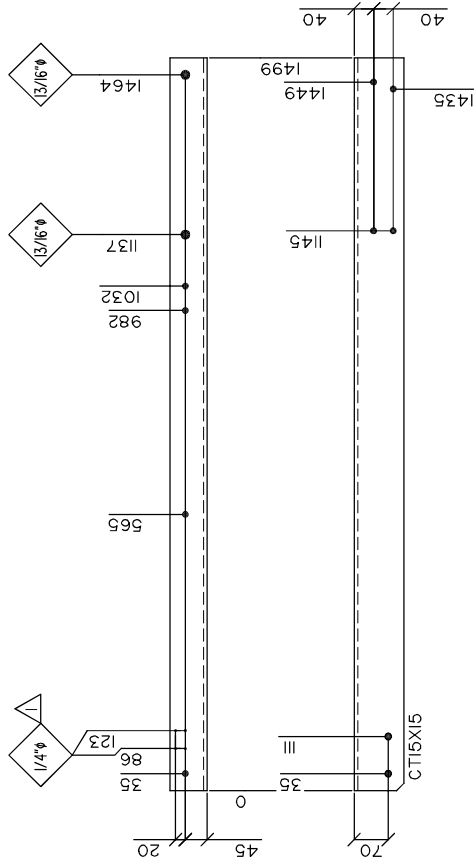

3	CONFORME A CSA S37-18 (CIMA+)	2019/11/28
2	GRADE CHANGED/NUANCE CHANGE	2006/03/22
1	HOLES ADDED/TROUS AJOUTS	2006/01/23
No	REVISION	DATE

Pêches et Océans
 Canada
 Gardie côtière
 Coast Guard



STEEL TOWERS / TOURS D'ACIER	
MATERIAL / MATÉRIEL	G40.21M
UN. FINISH / S.N. FINI	9/16" φ
DATE: 2005/12/08	
DRAWN / DESSINÉ	M. VACHON
CHECKED / VÉRIFIÉ	M. VACHON
FILE / DOSSIER	08990-SA
DRAWING / DESSIN	PO53

QTY	MRK	DESCRIPTION	LENGTH	GRADE	REMARK	WEIGHT	MRK	DESCRIPTION	LENGTH	GRADE	REMARK	WEIGHT
QT	MQE	DESCRIPTION	LONG.	NUANCE	REMARQUE	MASSE	MQE	DESCRIPTION	LONG.	NUANCE	REMARQUE	MASSE
1	PO53	L 102	76	350W	CLIP/CIS.	16.6						

WEIGHT / MASSE: 16.6 Kg

HEIGHT OF TOWER / HAUTEUR DE LA TOUR	10'	15'	20'	25'	30'	35'	40'	45'	50'	55'	60'	65'	70'	75'	80'
QUANTITY REQUIRED / QUANTITÉ REQUISE	1	1	1	1	1	1	1	1	1	1	1	0	0	0	0
ERECTION DRAWING / DESSIN DE MONTAGE	08990-SM-01	08990-SM-02	08990-SM-03	08990-SM-04	08990-SM-05	08990-SM-06	08990-SM-07	08990-SM-08	08990-SM-09	08990-SM-10	08990-SM-11	08990-SM-12	08990-SM-13	08990-SM-14	08990-SM-15

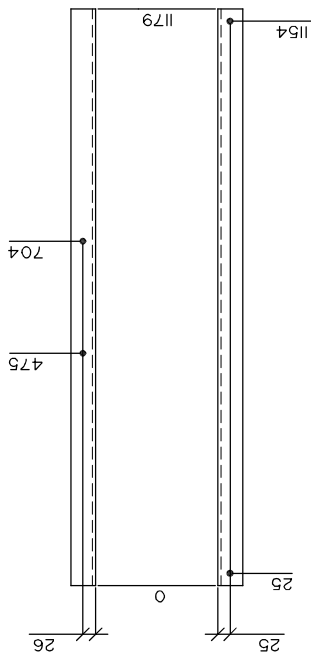

2	CONFORME A CSA S37-18 (CIMA+)	2019/11/28
1	GRADE CHANGED/NUANCE CHANGE	2006/03/22
No	REVISION	DATE

Pêches et Océans
 Canada
 Gardes côtière
 Coast Guard



STEEL TOWERS / TOURS D'ACIER
 MATERIAL: G40.21M UN. FINISH: GALV.
 MATERIEL: TROUS: 9/16"φ S.N. FINI: GALV.
 DRAWN: M.VACHON CHECKED: M.VACHON DATE: 2005/12/08
 DESSIN: VÉRIFÉ: DATE:
 SCALE: 1 = 10 FILE: 08990-SA DRAWING: POS4
 DOSSIER: DESSIN:

QTY	MRK	DESCRIPTION	LENGTH	GRADE	REMARK	WEIGHT	MRK	DESCRIPTION	LENGTH	GRADE	REMARK	WEIGHT
QT	MQE	DESCRIPTION	LONG.	NUANCE	REMARQUE	MASSE	MQE	DESCRIPTION	LONG.	NUANCE	REMARQUE	MASSE
1	PO54	L 51 51 6.35	1179	350W		5.8						
WEIGHT / MASSE: 5.8 Kg												

HEIGHT OF TOWER / HAUTEUR DE LA TOUR	10'	15'	20'	25'	30'	35'	40'	45'	50'	55'	60'	65'	70'	75'	80'
QUANTITY REQUIRED / QUANTITÉ REQUISE	0	0	0	0	0	0	0	0	0	0	0	0	0	0	0
ERECTION DRAWING / DESSIN DE MONTAGE	08990-SM-01	08990-SM-02	08990-SM-03	08990-SM-04	08990-SM-05	08990-SM-06	08990-SM-07	08990-SM-08	08990-SM-09	08990-SM-10	08990-SM-11	08990-SM-12	08990-SM-13	08990-SM-14	08990-SM-15

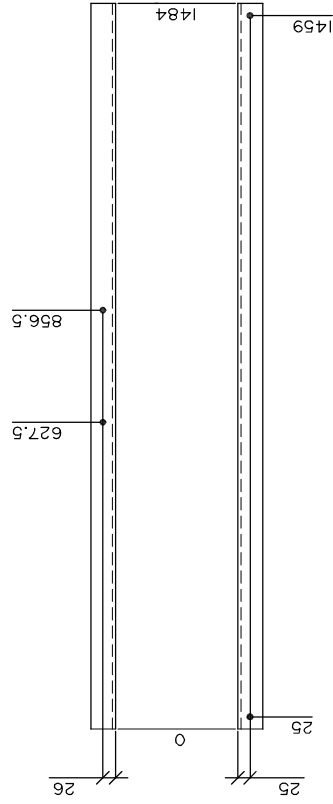

2019-12-03

2	CONFORME A CSA S37-18 (CIMA+)	2019/11/28
1	GRADE CHANGED/NUANCE CHANGE	2006/03/22
No	REVISION	DATE

Pêches et Océans
 Canada
 Gardie côtière
 Coast Guard



STEEL TOWERS / TOURS D'ACIER	
MATERIAL / MATÉRIEL	G40.21M
HOLES / TROUS	9/16" φ
UN. FINISH / S.N. FINI	GALV.
DRAWN / DESSINÉ	M. VACHON
CHECKED / VÉRIFIÉ	M. VACHON
DATE	2005/12/08
SCALE / ÉCHELLE	1 = 10
FILE / DOSSIER	08990-SA
DRAWING / DESSIN	PO55

QTY	MRK	DESCRIPTION	LENGTH	GRADE	REMARK	WEIGHT	MRK	DESCRIPTION	LENGTH	GRADE	REMARK	WEIGHT / MASSE	
												QTY	QTY
1	PO55	L 51 51 6.35 1484 350W	1484	350W		7.3							

HEIGHT OF TOWER / HAUTEUR DE LA TOUR	10'	15'	20'	25'	30'	35'	40'	45'	50'	55'	60'	65'	70'	75'	80'
QUANTITY REQUIRED / QUANTIT REQUISE	1	1	1	1	1	1	1	1	1	1	1	0	0	0	0
ERECTION DRAWING / DESSIN DE MONTAGE	08990-SM-01	08990-SM-02	08990-SM-03	08990-SM-04	08990-SM-05	08990-SM-06	08990-SM-07	08990-SM-08	08990-SM-09	08990-SM-10	08990-SM-11	08990-SM-12	08990-SM-13	08990-SM-14	08990-SM-15

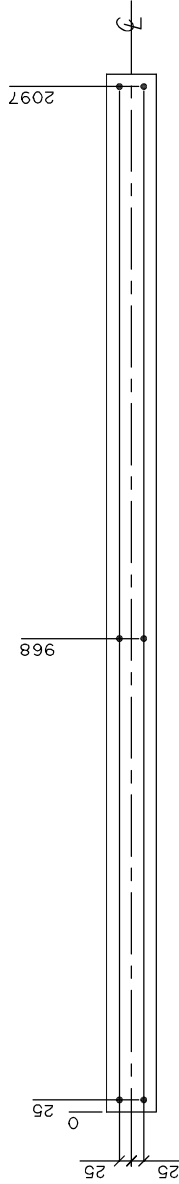

2019-12-03

2019-12-03

No	CONFORME A CSA S37-18 (CIMA+)	2019/11/28
REVISION		DATE
	Pêches et Océans Canada	Fisheries and Oceans Canada
	Garde côtière	Coast Guard

DESIGN MICHEL VACHON INC.
DESIGN TECHNIQUES / TECHNIQUES DE CONCEPTION
1100 Avenue de la Vallée
St-Jovite, Québec J0E 1S0-9S0

STEEL TOWERS / TOURS D'ACIER	
MATERIAL / MATÉRIEL	G40.21M
HOLES / TROUS	9/16" φ
UN. FINISH / S.N. FINI	GALV.
DRAWN / DESSINÉ	M.VACHON
CHECKED / VÉRIFIÉ	M.VACHON
DATE	2005/12/08
SCALE / ÉCHELLE	1 = 10
FILE / DOSSIER	08990-SA
DRAWING / DESSIN	PO56

QTY	MRK	DESCRIPTION	LENGTH	GRADE	REMARK	WEIGHT	MRK	DESCRIPTION	LENGTH	GRADE	REMARK	WEIGHT
QT	MQE	DESCRIPTION	LONG.	NUANCE	REMARQUE	MASSE	MQE	DESCRIPTION	LONG.	NUANCE	REMARQUE	MASSE
1	PO56	FB 6.35 X 102	2122	300W		11.1						

WEIGHT / MASSE: 11.1 Kg

HEIGHT OF TOWER / HAUTEUR DE LA TOUR	10'	15'	20'	25'	30'	35'	40'	45'	50'	55'	60'	65'	70'	75'	80'
QUANTITY REQUIRED / QUANTIT REQUISE	2	2	2	2	2	2	2	2	2	2	2	0	0	0	0
ERECTION DRAWING / DESSIN DE MONTAGE	08990-SM-01	08990-SM-02	08990-SM-03	08990-SM-04	08990-SM-05	08990-SM-06	08990-SM-07	08990-SM-08	08990-SM-09	08990-SM-10	08990-SM-11	08990-SM-12	08990-SM-13	08990-SM-14	08990-SM-15

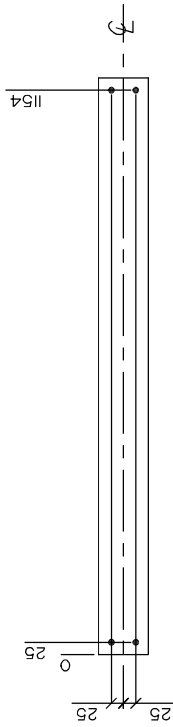

I	CONFORME A CSA S37-18 (CIMA+)	2019/11/28
No	REVISION	DATE
	Pêches et Océans Canada	Fisheries and Oceans Canada
	Garde côtière	Coast Guard

QTY	MRK	DESCRIPTION	LENGTH	GRADE	REMARK	WEIGHT	WEIGHT
QT	MQE	DESCRIPTION	LONG.	NUANCE	REMARQUE	MASSE	MASSE
1	POST	FB 6.35 X 102	1179	300W		6.2	6.2 Kg

WEIGHT / MASSE: 6.2 Kg

DESIGN MICHEL VACHON INC. DESIGN DE STRUCTURES ET FACILITES 11-PROBLEME, 11000-1000	
MATERIAL MATERIEL	G40.21M
DRAWN DESSIN	M.VACHON
CHECKED VERIFIE	M.VACHON
SCALE ECHALE	1 = 10
FILES DOSSIER	08990-SA
DATE	2005/12/08
FINISH FINIS	GALV.
UN. / S.N.	9/16"φ
DATE	2005/12/08
DRAWING	POST

STEEL TOWERS / TOURS D'ACIER

HEIGHT OF TOWER / HAUTEUR DE LA TOUR	10'	15'	20'	25'	30'	35'	40'	45'	50'	55'	60'	65'	70'	75'	80'
QUANTITY REQUIRED / QUANTITÉ REQUISE	1	1	1	1	1	1	1	1	1	1	1	0	0	0	0
ERECTION DRAWING / DESSIN DE MONTAGE	08990-SM-01	08990-SM-02	08990-SM-03	08990-SM-04	08990-SM-05	08990-SM-06	08990-SM-07	08990-SM-08	08990-SM-09	08990-SM-10	08990-SM-11	08990-SM-12	08990-SM-13	08990-SM-14	08990-SM-15

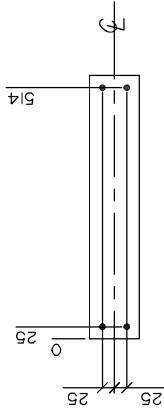

I	CONFORME A CSA S37-18 (CIMA+)	2019/11/28
No	REVISION	DATE
	Pêches et Océans Canada Gardie côtière Coast Guard	Fisheries and Oceans Canada Coast Guard

QTY	MRK	DESCRIPTION	LENGTH	GRADE	REMARK	WEIGHT	MRK	DESCRIPTION	LENGTH	GRADE	REMARK	WEIGHT
QT	MQE	DESCRIPTION	LONG.	NUANCE	REMARQUE	MASSE	MQE	DESCRIPTION	LONG.	NUANCE	REMARQUE	MASSE
1	PO58	FB 6.35 X 102	539	300W		2.8						

WEIGHT / MASSE: 2.8 Kg

STEEL TOWERS / TOURS D'ACIER	
MATERIAL / MATÉRIEL: G40.21M	UN. / FINISH: GALV.
HOLES / TROUS: 9/16"φ	S.N. / FINI: GALV.
DRAWN / DESSIN: M.VACHON	CHECKED / VÉRIFIÉ: M.VACHON
DATE: 2005/12/08	FILE: 08990-SA
SCALED: 1 = 10	DRAWING: PO58
	DESSIN: PO58



HEIGHT OF TOWER / HAUTEUR DE LA TOUR	10'	15'	20'	25'	30'	35'	40'	45'	50'	55'	60'	65'	70'	75'	80'
QUANTITY REQUIRED / QUANTIT REQUISE	1	1	1	1	1	1	1	1	1	1	1	0	0	0	0
ERECTION DRAWING / DESSIN DE MONTAGE	08990-SM-01	08990-SM-02	08990-SM-03	08990-SM-04	08990-SM-05	08990-SM-06	08990-SM-07	08990-SM-08	08990-SM-09	08990-SM-10	08990-SM-11	08990-SM-12	08990-SM-13	08990-SM-14	08990-SM-15

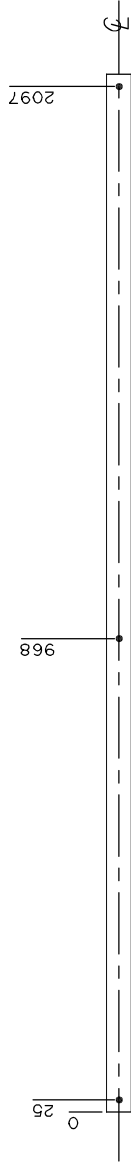

I	CONFORME A CSA S37-18 (CIMA+)	2019/11/28
No	REVISION	DATE
	Pêches et Océans Canada	Fisheries and Oceans Canada
	Garde côtière	Coast Guard

DESSIN MICHEVAL ACTION INC. DESSIN DES STRUCTURES EN ACIER 1100, rue de la Vallée, Québec, Québec H2V 1K6	
STEEL TOWERS / TOURS D'ACIER	
MATERIAL / MATÉRIEL	G40.21M
HOLES / TROUS	9/16"φ
UN. FINISH / S.N. FINI	GALV.
DRAWN / DESSINÉ	M.VACHON
CHECKED / VÉRIFIÉ	M.VACHON
DATE	2005/12/08
SCALE / ÉCHELLE	1 = 10
FILE / DOSSIER	08990-SA
DRAWING / DESSIN	PO59

QTY	MRK	DESCRIPTION	LENGTH	GRADE	REMARK	WEIGHT	WEIGHT
QT	MQE	DESCRIPTION	LONG.	NUANCE	REMARQUE	MASSE	MASSE
1	PO59	FB 6.35 X 51	2122	300W		5.6	

WEIGHT / MASSE: 5.6 Kg

HEIGHT OF TOWER / HAUTEUR DE LA TOUR	10'	15'	20'	25'	30'	35'	40'	45'	50'	55'	60'	65'	70'	75'	80'
QUANTITY REQUIRED / QUANTITE REQUISE	1	1	1	1	1	1	1	1	1	1	1	0	0	0	0
ERECTION DRAWING / DESSIN DE MONTAGE	08990-SM-01	08990-SM-02	08990-SM-03	08990-SM-04	08990-SM-05	08990-SM-06	08990-SM-07	08990-SM-08	08990-SM-09	08990-SM-10	08990-SM-11	08990-SM-12	08990-SM-13	08990-SM-14	08990-SM-15

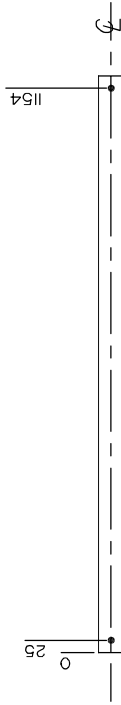

I	CONFORME A CSA S37-18 (CIMA+)	2019/11/28
No	REVISION	DATE
	Pêches et Océans Canada	Fisheries and Oceans Canada
	Garde côtière	Coast Guard

QTY	MRK	DESCRIPTION	LENGTH	GRADE	REMARK	WEIGHT	MRK	DESCRIPTION	LENGTH	GRADE	REMARK	WEIGHT
QT	MQE	DESCRIPTION	LONG.	NUANCE	REMARQUE	MASSE	MQE	DESCRIPTION	LONG.	NUANCE	REMARQUE	MASSE
1	P060	FB 6.35 X 51	1179	300W		3.1						

STEEL TOWERS / TOURS D'ACIER	
MATERIAL / MATERIEL	G40.21M
HOLES / TROUS	9/16" φ
FINISH / FINI	GALV.
DRAWN / DESSINÉ	M.VACHON
CHECKED / VÉRIFIÉ	M.VACHON
DATE	2005/12/08
FILE / DOSSIER	08990-SA
DRAWING / DESSIN	P060

WEIGHT / MASSE: 3.1 Kg

DESIGN MICHEL VACHON INC.
DESIGNER / CONCEPTEUR: M. VACHON
1100 BOULEVARD
1100 BOULEVARD, 1100 BOULEVARD

HEIGHT OF TOWER / HAUTEUR DE LA TOUR	10'	15'	20'	25'	30'	35'	40'	45'	50'	55'	60'	65'	70'	75'	80'
QUANTITY REQUIRED / QUANTIT REQUISE	1	1	1	1	1	1	1	1	1	1	1	0	0	0	0
ERECTION DRAWING / DESSIN DE MONTAGE	08990-SM-01	08990-SM-02	08990-SM-03	08990-SM-04	08990-SM-05	08990-SM-06	08990-SM-07	08990-SM-08	08990-SM-09	08990-SM-10	08990-SM-11	08990-SM-12	08990-SM-13	08990-SM-14	08990-SM-15

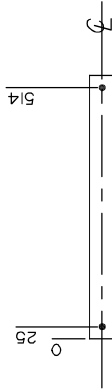

2019-12-03

2019-12-03

I	CONFORME A CSA S37-18 (CIMA+)	2019/11/28
No	REVISION	DATE
	Pêches et Océans Canada Gardie côtière Coast Guard	

		WEIGHT / MASSE:		1.4 Kg		
QTY	MRK	DESCRIPTION	LENGTH	GRADE	REMARK	WEIGHT
QT	MQE	DESCRIPTION	LONG.	NUANCE	REMARQUE	MASSE
1	P062	FB 6.35 X 51	539	300W		1.4



STEEL TOWERS / TOURS D'ACIER	
MATERIAL / MATÉRIEL:	G40.21M
HOLES / TROUS:	9/16"φ
FINISH / FINI:	GALV.
DRAWN / DESSINÉ:	M.VACHON
CHECKED / VÉRIFIÉ:	M.VACHON
DATE:	2005/12/08
FILE / DOSSIER:	08990-SA
DRAWING / DESSIN:	P062

HEIGHT OF TOWER / HAUTEUR DE LA TOUR	10'	15'	20'	25'	30'	35'	40'	45'	50'	55'	60'	65'	70'	75'	80'
QUANTITY REQUIRED / QUANTITÉ REQUISE	0	0	0	0	0	0	0	0	0	0	0	2	2	2	2
ERECTION DRAWING / DESSIN DE MONTAGE	08990-SM-01	08990-SM-02	08990-SM-03	08990-SM-04	08990-SM-05	08990-SM-06	08990-SM-07	08990-SM-08	08990-SM-09	08990-SM-10	08990-SM-11	08990-SM-12	08990-SM-13	08990-SM-14	08990-SM-15

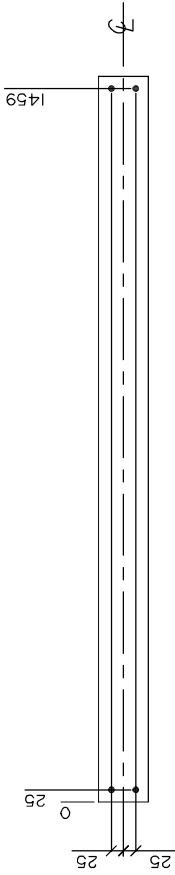

I	CONFORME A CSA S37-18 (CIMA+)	2019/11/28
No	REVISION	DATE
	Pêches et Océans Canada	Fisheries and Oceans Canada
	Garde côtière	Coast Guard



QTY	MRK	DESCRIPTION	LENGTH	GRADE	REMARK	WEIGHT	MRK	DESCRIPTION	LENGTH	GRADE	REMARK	WEIGHT
QT	MQE	DESCRIPTION	LONG.	NUANCE	REMARQUE	MASSE	MQE	DESCRIPTION	LONG.	NUANCE	REMARQUE	MASSE
1	P064	FB 6.35 X 102	1484	300W		7.8						

STEEL TOWERS / TOURS D'ACIER	
MATERIAL / MATÉRIEL	G40.21M
HOLES / TROUS	9/16"φ
UN. FINISH / S.N. FINI	GALV.
DRAWN / DESSINÉ	M.VACHON
CHECKED / VÉRIFIÉ	M.VACHON
DATE	2005/12/08
SCALE / ÉCHELLE	1 = 10
FILE / DOSSIER	08990-SA
DRAWING / DESSIN	P064

WEIGHT / MASSE: 7.8 Kg

HEIGHT OF TOWER / HAUTEUR DE LA TOUR	10'	15'	20'	25'	30'	35'	40'	45'	50'	55'	60'	65'	70'	75'	80'
QUANTITY REQUIRED / QUANTIT REQUISE	0	0	0	0	0	0	0	0	0	0	0	1	1	1	1
ERECTION DRAWING / DESSIN DE MONTAGE	08990-SM-01	08990-SM-02	08990-SM-03	08990-SM-04	08990-SM-05	08990-SM-06	08990-SM-07	08990-SM-08	08990-SM-09	08990-SM-10	08990-SM-11	08990-SM-12	08990-SM-13	08990-SM-14	08990-SM-15

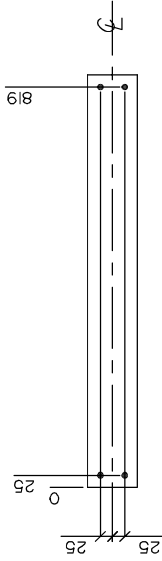

No	CONFORME A CSA S37-18 (CIMA+)	2019/11/28
REVISION	DATE	
1	Pêches et Océans Canada	2019/11/28
	Garde côtière Coast Guard	
 DESSIN MICHEL VACHON INC. DESSIN DES STRUCTURES EN ACIER 1100, rue de la Vallée, Québec, Québec H2V 1K6		
STEEL TOWERS / TOURS D'ACIER		
MATERIAL / MATÉRIEL	G40.21M	UN. FINISH / S.N. FINI
HOLES / TROUS	9/16"φ	GALV.
DRAWN / DESSINÉ	M.VACHON	DATE: 2005/12/08
CHECKED / VÉRIFIÉ	M.VACHON	DRAWING / DESSIN
SCALE / ÉCHELLE	1 = 10	FILE / DOSSIER: 08990-SA
		P065

QTY QT	MRK MQE	DESCRIPTION	LENGTH LONG.	GRADE NUANCE	REMARK REMARQUE	WEIGHT MASSE	REMARK REMARQUE
1	P065	FB 6.35 X 102	844	300W		4.4	

WEIGHT / MASSE: 4.4 Kg

HEIGHT OF TOWER / HAUTEUR DE LA TOUR	10'	15'	20'	25'	30'	35'	40'	45'	50'	55'	60'	65'	70'	75'	80'
QUANTITY REQUIRED / QUANTIT REQUISE	0	0	0	0	0	0	0	0	0	0	0	0	0	0	0
ERECTION DRAWING / DESSIN DE MONTAGE	08990-SM-01	08990-SM-02	08990-SM-03	08990-SM-04	08990-SM-05	08990-SM-06	08990-SM-07	08990-SM-08	08990-SM-09	08990-SM-10	08990-SM-11	08990-SM-12	08990-SM-13	08990-SM-14	08990-SM-15

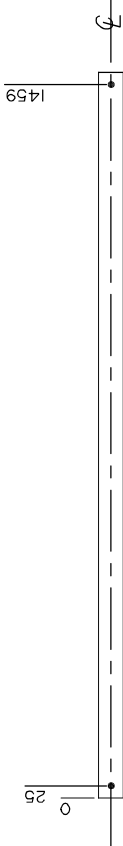



I	CONFORME A CSA S37-18 (CIMA+)	2019/11/28
No	REVISION	DATE
	Pêches et Océans Canada Gardie côtière Coast Guard	Fisheries and Oceans Canada Coast Guard

DESSIN MICHEL VACHON INC. DESSIN DES STRUCTURES EN ACIER 1100, rue de la Vallée, Québec, Québec G1R 1A6	
STEEL TOWERS / TOURS D'ACIER	
MATERIAL / MATÉRIEL	G40.21M
HOLES / TROUS	9/16" φ
UN. FINISH / S.N. FINI	GALV.
DRAWN / DESSINÉ	M.VACHON
CHECKED / VÉRIFIÉ	M.VACHON
DATE	2005/12/08
SCALE / ÉCHELLE	1 = 10
FILE / DOSSIER	08990-SA
DRAWING / DESSIN	P067

QTY	MRK	DESCRIPTION	LENGTH	GRADE	REMARK	WEIGHT	MRK	DESCRIPTION	LENGTH	GRADE	REMARK	WEIGHT
QT	MQE	DESCRIPTION	LONG.	NUANCE	REMARQUE	MASSE	MQE	DESCRIPTION	LONG.	NUANCE	REMARQUE	MASSE
1	P067	FB 6.35 X 51	1484	300W		3.9						
WEIGHT / MASSE: 3.9 Kg												

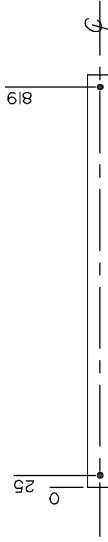
HEIGHT OF TOWER / HAUTEUR DE LA TOUR	10'	15'	20'	25'	30'	35'	40'	45'	50'	55'	60'	65'	70'	75'	80'
QUANTITY REQUIRED / QUANTITÉ REQUISE	0	0	0	0	0	0	0	0	0	0	0	0	0	0	0
ERECTION DRAWING / DESSIN DE MONTAGE	08990-SM-01	08990-SM-02	08990-SM-03	08990-SM-04	08990-SM-05	08990-SM-06	08990-SM-07	08990-SM-08	08990-SM-09	08990-SM-10	08990-SM-11	08990-SM-12	08990-SM-13	08990-SM-14	08990-SM-15



I	CONFORME A CSA S37-18 (CIMA+)	2019/11/28
No	REVISION	DATE
	 Pêches et Océans Canada Gardie côtière Coast Guard	Fisheries and Oceans Canada Coast Guard

QTY	MRK	DESCRIPTION	LENGTH	GRADE	REMARK	WEIGHT	MRK	DESCRIPTION	LENGTH	GRADE	REMARK	WEIGHT
QT	MQE	DESCRIPTION	LONG.	NUANCE	REMARQUE	MASSE	MQE	DESCRIPTION	LONG.	NUANCE	REMARQUE	MASSE
1	P068	FB 6.35 X 51	844	300W		2.2						

WEIGHT / MASSE: 2.2 Kg

STEEL TOWERS / TOURS D'ACIER												
MATERIAL:	G40.21M	HOLES:	9/16"φ	UN. FINISH:	GALV.							
MATERIEL:	M.VACHON	TROUS:	9/16"φ	S.N. FINI:								
DRAWN:	M.VACHON	CHECKED:	M.VACHON	DATE:	2005/12/08							
DESIGN:		VERIFIE:		DATE:								
SCALE:	1 = 10	FILE:	08990-SA	DRAWING:	P068							
		DOSSIER:		DESSIN:								



HEIGHT OF TOWER / HAUTEUR DE LA TOUR	10'	15'	20'	25'	30'	35'	40'	45'	50'	55'	60'	65'	70'	75'	80'
QUANTITY REQUIRED / QUANTITÉ REQUISE	2	2	2	2	2	2	2	2	2	2	2	2	2	2	2
ERECTION DRAWING / DESSIN DE MONTAGE	08990-SM-01	08990-SM-02	08990-SM-03	08990-SM-04	08990-SM-05	08990-SM-06	08990-SM-07	08990-SM-08	08990-SM-09	08990-SM-10	08990-SM-11	08990-SM-12	08990-SM-13	08990-SM-14	08990-SM-15

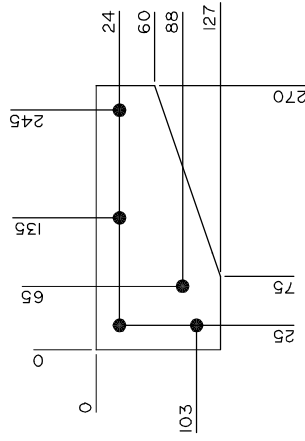

No	CONFORME A CSA S37-18 (CIMA+)	2019/11/28
REVISION		DATE
	 Pêches et Océans Canada	Fisheries and Oceans Canada
	Garde côtière	Coast Guard

QTY	MRK	DESCRIPTION	LENGTH	GRADE	REMARK	WEIGHT	MRK	DESCRIPTION	LENGTH	GRADE	REMARK	WEIGHT
QT	MQE	DESCRIPTION	LONG.	NUANCE	REMARQUE	MASSE	MQE	DESCRIPTION	LONG.	NUANCE	REMARQUE	MASSE
1	P069	FB 9.53 X 127	270	300W		2.1						
WEIGHT / MASSE: 2.1 Kg												
STEEL TOWERS / TOURS D'ACIER MATERIAL: G40.21M HOLES: 9/16"φ UN. FINISH: GALV. DRAWN: M.VACHON CHECKED: M.VACHON DATE: 2005/12/08 SCALE: 1 = 5 FILE: 08990-SA DRAWING: P069												



HEIGHT OF TOWER / HAUTEUR DE LA TOUR	10'	15'	20'	25'	30'	35'	40'	45'	50'	55'	60'	65'	70'	75'	80'
QUANTITY REQUIRED / QUANTIT REQUISE	2	2	2	2	2	2	2	2	2	2	2	2	2	2	2
ERECTION DRAWING / DESSIN DE MONTAGE	08990-SM-01	08990-SM-02	08990-SM-03	08990-SM-04	08990-SM-05	08990-SM-06	08990-SM-07	08990-SM-08	08990-SM-09	08990-SM-10	08990-SM-11	08990-SM-12	08990-SM-13	08990-SM-14	08990-SM-15

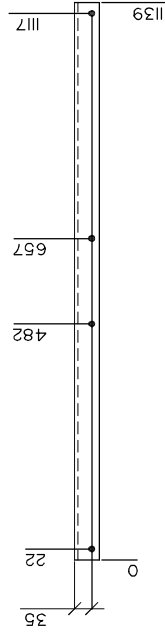

2	CONFORME A CSA S37-18 (CIMA+)	2019/11/28
1	GRADE CHANGED/NUANCE CHANGE	2006/03/22
No	REVISION	DATE

 Pêches et Océans
 Canada
 Fisheries and Oceans
 Canada

Garde côtière
Coast Guard



DESSIN MICHEL VACHON INC.
 DESSIN DES STRUCTURES EN ACIER
 1100, rue de la Vallée, Québec, Québec G1R 1A6
 Tél: (514) 382-1000

STEEL TOWERS / TOURS D'ACIER	
MATERIAL / MATÉRIEL	G40.21M
HOLES / TROUS	9/16" φ
UN. FINISH / S.N. FINI	GALV.
DRAWN / DESSINÉ	M. VACHON
CHECKED / VÉRIFIÉ	M. VACHON
DATE	2005/12/12
SCALE / ÉCHELLE	1 = 10
FILE / DOSSIER	08990-SA
DRAWING / DESSIN	POTO

WEIGHT / MASSE: 5.6 Kg

QTY QT	MRK MQE	DESCRIPTION	LENGTH LONG.	GRADE NUANCE	REMARK REMARQUE	WEIGHT MASSE	DESCRIPTION	LENGTH LONG.	GRADE NUANCE	REMARK REMARQUE	WEIGHT MASSE
1	POTO	L 51 51 6.35	1139	350W		5.6					

HEIGHT OF TOWER / HAUTEUR DE LA TOUR	10'	15'	20'	25'	30'	35'	40'	45'	50'	55'	60'	65'	70'	75'	80'
QUANTITY REQUIRED / QUANTIT REQUISE	1	1	1	1	1	1	1	1	1	1	1	1	1	1	1
ERECTION DRAWING / DESSIN DE MONTAGE	08990-SM-01	08990-SM-02	08990-SM-03	08990-SM-04	08990-SM-05	08990-SM-06	08990-SM-07	08990-SM-08	08990-SM-09	08990-SM-10	08990-SM-11	08990-SM-12	08990-SM-13	08990-SM-14	08990-SM-15

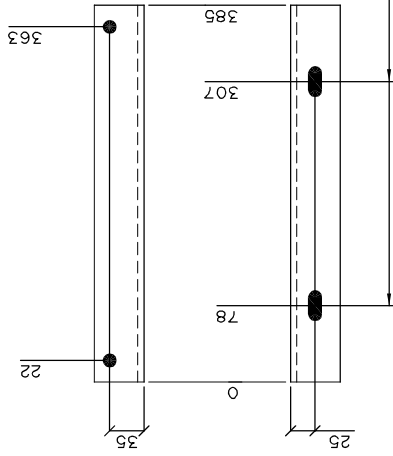

9/16" X 1 1/4" SLOTTED HOLE
TROUS OBLONGS 14.3 X 36



2019-12-03



2019-12-03

2	CONFORME A CSA S37-18 (CIMA+)	2019/11/28
1	GRADE CHANGED/NUANCE CHANGE	2006/03/22
No	REVISION	DATE



Pêches et Océans
Canada

Garde côtière
Coast Guard



DESSIN MICHEL VACHON INC.
1400 RUE DES PÊCHES WILHELMSTADT
1-800-461-4336
1-COULBURN 148 128-7940

WEIGHT / MASSE: 1.9 Kg

QTY	MRK MOE	DESCRIPTION	LENGTH LONG.	GRADE NUANCE	REMARK REMARQUE	WEIGHT MASSE	QTY	MRK MOE	DESCRIPTION	LENGTH LONG.	GRADE NUANCE	REMARK REMARQUE	WEIGHT MASSE	
1	P-071	L 51 51 6.35	385	350W		1.9								
STEEL TOWERS / TOURS D'ACIER														
		MATERIAL:	G40.21M	HOLES TROUS:	9/16"φ	FINISH:	UN. FINI:							
		DRAWN:	M.VACHON	CHECKED:	M.VACHON	DATE:	2005/12/12							
		SCALE:	1 = 5	FILE:	08990-SA	DRAWING:	P-071							

HEIGHT OF TOWER / HAUTEUR DE LA TOUR		10'	15'	20'	25'	30'	35'	40'	45'	50'	55'	60'	65'	70'	75'	80'
QUANTITY REQUIRED / QUANTITÉ REQUISE		3	3	3	3	3	3	3	3	3	3	3	3	3	3	3
ERECTION DRAWING / DESSIN DE MONTAGE		08990-SM-01	08990-SM-02	08990-SM-03	08990-SM-04	08990-SM-05	08990-SM-06	08990-SM-07	08990-SM-08	08990-SM-09	08990-SM-10	08990-SM-11	08990-SM-12	08990-SM-13	08990-SM-14	08990-SM-15

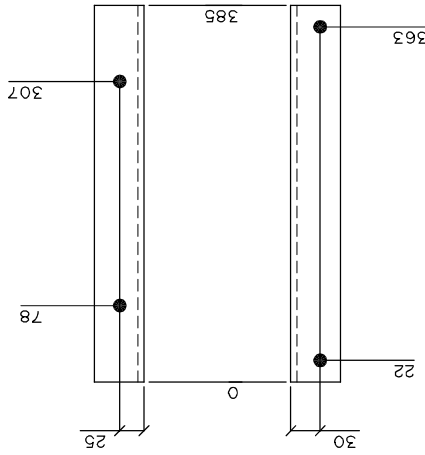

2019-12-03

2	CONFORME A CSA S37-18 (CIMA+)	2019/11/28
1	GRADE CHANGED/NUANCE CHANGE	2006/03/22
No	REVISION	DATE



 Pêches et Océans
 Canada
 Garde côtière
 Coast Guard



STEEL TOWERS / TOURS D'ACIER		
MATERIAL: G40.21M	HOLES: 9/16" φ	U.N. FINISH: GALV.
DESIGN: M.VACHON	VERIFIED: M.VACHON	DATE: 2005/12/12
SCALE: 1 = 5	FILE: 08990-SA	DRAWING: P072
	DOSSIER: 08990-SA	DESSIN: P072

QTY	MRK	DESCRIPTION	LENGTH	GRADE	REMARK	WEIGHT	WEIGHT / MASSE:		REMARK
							QTY	KG	
QT	MQE	DESCRIPTION	LONG.	NUANCE	REMARQUE	MASSE	QT	MASSE	REMARQUE
1	P072	L 51 51 6.35	385	350W		1.9			

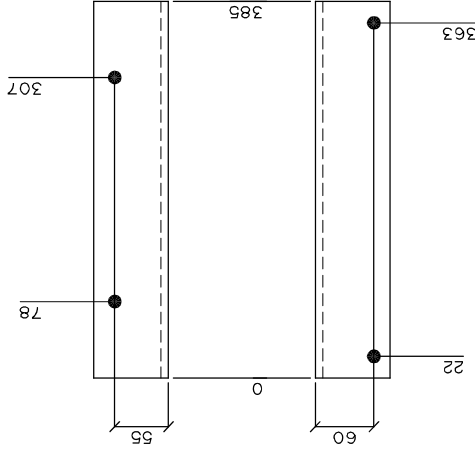
HEIGHT OF TOWER / HAUTEUR DE LA TOUR QUANTITY REQUIRED / QUANTIT REQUISE	10'	15'	20'	25'	30'	35'	40'	45'	50'	55'	60'	65'	70'	75'	80'
ERECTION DRAWING / DESSIN DE MONTAGE	08890-SM-01	08890-SM-02	08890-SM-03	08890-SM-04	08890-SM-05	08890-SM-06	08890-SM-07	08890-SM-08	08890-SM-09	08890-SM-10	08890-SM-11	08890-SM-12	08890-SM-13	08890-SM-14	08890-SM-15



2	CONFORME A CSA S37-18 (CIMA+)	2019/11/28
1	GRADE CHANGED/NUANCE CHANGE	2006/03/22
No	REVISION	DATE

 Pêches et Océans
 Canada
 Gardes côtière
 Coast Guard



STEEL TOWERS / TOURS D'ACIER	
MATERIAL: G40.21M	HOLES: 9/16" φ
PROCESSED: M.VACHON	U.N. FINISH: GALV.
DESIGN DATE: 2005/12/13	FILE: 08890-SA
SCALE: 1 = 5	DRAWING: P073

QTY	MRK	DESCRIPTION	LENGTH	GRADE	REMARK	WEIGHT	QTY	MRK	DESCRIPTION	LENGTH	GRADE	REMARK	WEIGHT
QT	MQE	DESCRIPTION	LONG.	NUANCE	REMARQUE	MASSE	QT	MQE	DESCRIPTION	LONG.	NUANCE	REMARQUE	MASSE
1	P073	L 76 76	385	350W		3.6							

WEIGHT / MASSE: 3.6 Kg

HEIGHT OF TOWER / HAUTEUR DE LA TOUR QUANTITY REQUIRED / QUANTIT REQUISE	10'	15'	20'	25'	30'	35'	40'	45'	50'	55'	60'	65'	70'	75'	80'
ERECTION DRAWING / DESSIN DE MONTAGE	08890-SM-01	08890-SM-02	08890-SM-03	08890-SM-04	08890-SM-05	08890-SM-06	08890-SM-07	08890-SM-08	08890-SM-09	08890-SM-10	08890-SM-11	08890-SM-12	08890-SM-13	08890-SM-14	08890-SM-15

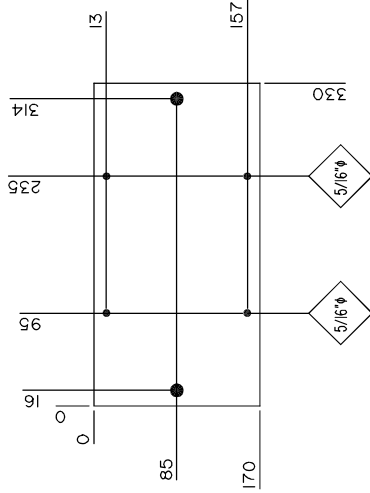

2019-12-03

2019-12-03

I	CONFORME A CSA S37-18 (CIMA+)	2019/11/28
No	REVISION	DATE
Pêches et Océans Canada Garde côtière Coast Guard		
DESSIN MICHEL VACHON INC. DESSIN DES STRUCTURES METALLIQUES 1-COULBURE, TEL: 508-7908		
STEEL TOWERS / TOURS D'ACIER		
MATERIAL:	G40.21M	HOLES: 9/16" Ø
FINISH:		U.N. FINISH: GALV.
DESIGNED BY:	M.VACHON	PROJ. NO: M.VACHON
CHECKED BY:		DATE: 2005/12/13
SCALE:	1 = 5	FILE: 08890-SA
DRAWING NO:		DESSIN: P074

QTY	MRK	DESCRIPTION	LENGTH	GRADE	REMARK	WEIGHT	QTY	MRK	DESCRIPTION	LENGTH	GRADE	REMARK	WEIGHT
QT	MQE	DESCRIPTION	LONG.	NUANCE	REMARQUE	MASSE	QT	MQE	DESCRIPTION	LONG.	NUANCE	REMARQUE	MASSE
1	P074	PL 3.18 X 170	330	300W		1.4							

HEIGHT OF TOWER / HAUTEUR DE LA TOUR	10'	15'	20'	25'	30'	35'	40'	45'	50'	55'	60'	65'	70'	75'	80'
QUANTITY REQUIRED / QUANTITÉ REQUISE	2	2	2	2	2	2	2	2	2	2	2	2	2	2	2
ERECTION DRAWING / DESSIN DE MONTAGE	08990-SM-01	08990-SM-02	08990-SM-03	08990-SM-04	08990-SM-05	08990-SM-06	08990-SM-07	08990-SM-08	08990-SM-09	08990-SM-10	08990-SM-11	08990-SM-12	08990-SM-13	08990-SM-14	08990-SM-15

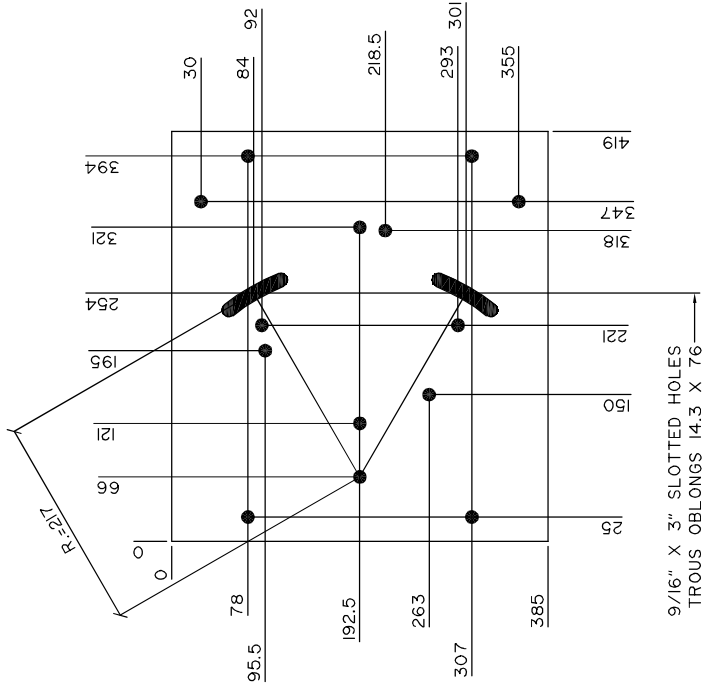

I	CONFORME A CSA S37-18 (CIMA+)	2019/11/28
No	REVISION	DATE

Pêches et Océans
 Canada
 Garde côtière
 Coast Guard

DESSIN MICHEL VACHON INC.
 DESSIN DES STRUCTURES MÉTALLIQUES
 1-COPELIC, 4441 688-7900

STEEL TOWERS / TOURS D'ACIER	
MATERIAL: G40.21M	HOLES: 9/16" φ
DESIGN: M.VACHON	U.N. FINISH: GALV.
SCALE: 1 = 5	DATE: 2005/12/13
FILE: 08990-SA	DRAWING: P075

QTY	MRK	DESCRIPTION	LENGTH	GRADE	REMARK	WEIGHT	DESCRIPTION	LENGTH	GRADE	REMARK	WEIGHT
QT	MQE	DESCRIPTION	LONG.	NUANCE	REMARQUE	MASSE	DESCRIPTION	LONG.	NUANCE	REMARQUE	MASSE
1	P075	PL 6.35 X 385	419	300W		8.3					

HEIGHT OF TOWER / HAUTEUR DE LA TOUR	10'	15'	20'	25'	30'	35'	40'	45'	50'	55'	60'	65'	70'	75'	80'
QUANTITY REQUIRED / QUANTIT REQUISE	1	1	1	1	1	1	1	1	1	1	1	1	1	1	1
ERECTION DRAWING / DESSIN DE MONTAGE	08990-SM-01	08990-SM-02	08990-SM-03	08990-SM-04	08990-SM-05	08990-SM-06	08990-SM-07	08990-SM-08	08990-SM-09	08990-SM-10	08990-SM-11	08990-SM-12	08990-SM-13	08990-SM-14	08990-SM-15

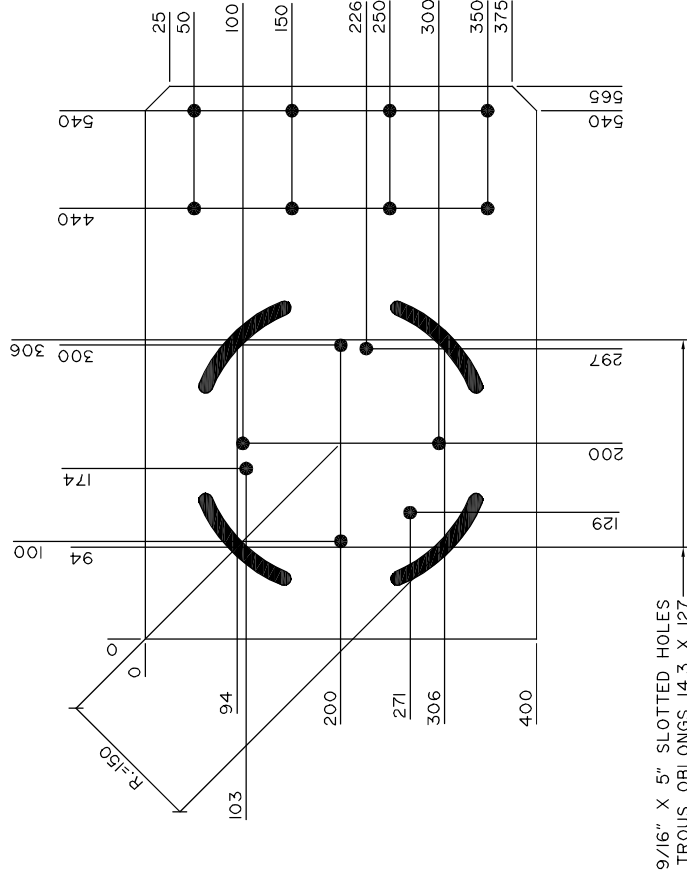

9/16" X 5" SLOTTED HOLES
TROUS OBLONGS 14.3 X 127



I	CONFORME A CSA S37-18 (CIMA+)	2019/11/28
No	REVISION	DATE

Pêches et Océans
 Canada
 Garde côtière
 Coast Guard



STEEL TOWERS / TOURS D'ACIER	
MATERIAL: G40.21M	HOLES: 9/16" φ
FINISH: GALV.	U.N. FINISH: GALV.
DESIGNER: M.VACHON	VERIFIED: M.VACHON
DATE: 2005/12/14	DATE: 2005/12/14
SCALE: 1 = 5	FILE: 08990-SA
DRAWING: P076	DESSIN: P076

QTY	MRK	DESCRIPTION	LENGTH	GRADE	REMARK	WEIGHT	MRK	DESCRIPTION	LENGTH	GRADE	REMARK	WEIGHT
QT	MQE	DESCRIPTION	LONG.	NUANCE	REMARQUE	MASSE	MQE	DESCRIPTION	LONG.	NUANCE	REMARQUE	MASSE
1	P076	PL 6.35 X 400	565	300W		11.7						

HEIGHT OF TOWER / HAUTEUR DE LA TOUR	10'	15'	20'	25'	30'	35'	40'	45'	50'	55'	60'	65'	70'	75'	80'
QUANTITY REQUIRED / QUANTIT REQUISE	1	1	1	1	1	1	1	1	1	1	1	1	1	1	1
ERECTION DRAWING / DESSIN DE MONTAGE	08990-SM-01	08990-SM-02	08990-SM-03	08990-SM-04	08990-SM-05	08990-SM-06	08990-SM-07	08990-SM-08	08990-SM-09	08990-SM-10	08990-SM-11	08990-SM-12	08990-SM-13	08990-SM-14	08990-SM-15

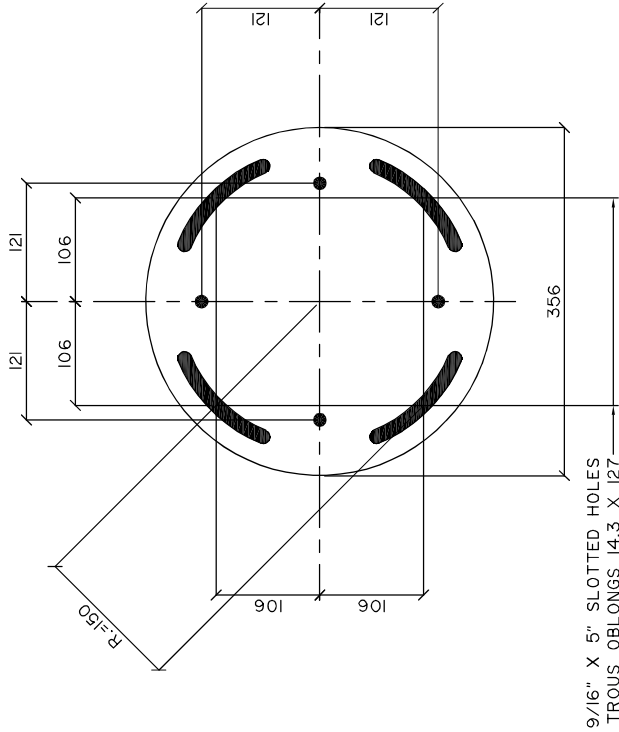

9/16" X 5" SLOTTED HOLES
TROUS OBLONGS 14.3 X 127



2	CONFORME A CSA S37-18 (CIMA+)	2019/11/28
1	DIAMETRE ET PAISSEUR REVIS	2006/01/19
No	REVISION	DATE

Pêches et Océans
Canada
Fisheries and Oceans
Canada

Garde côtière
Coast Guard



STEEL TOWERS / TOURS D'ACIER	
MATERIAL: G40.21M	HOLES: 9/16" φ
UN. FINISH: GALV.	S.N. FINISH: GALV.
DESIGN: M.VACHON	VERIFIED: M.VACHON
DATE: 2005/12/14	DATE: 2005/12/14
SCALE: 1 = 5	FILE: 08990-SA
DRAWING: P077	DESSIN: P077

QTY	MRK	DESCRIPTION	LENGTH	GRADE	REMARK	WEIGHT	WEIGHT
QT	MOE	DESCRIPTION	LONG.	NUANCE	REMARQUE	MASSE	MASSE
			LONG.			QT	QT
1	P077	PL 4.76 X	356φ	300W		3.9	

WEIGHT / MASSE: 3.9 Kg

HEIGHT OF TOWER / HAUTEUR DE LA TOUR	10'	15'	20'	25'	30'	35'	40'	45'	50'	55'	60'	65'	70'	75'	80'
QUANTITY REQUIRED / QUANTITÉ REQUISE	2	2	2	2	2	2	2	2	2	2	2	2	2	2	2
ERECTION DRAWING / DESSIN DE MONTAGE	08990-SM-01	08990-SM-02	08990-SM-03	08990-SM-04	08990-SM-05	08990-SM-06	08990-SM-07	08990-SM-08	08990-SM-09	08990-SM-10	08990-SM-11	08990-SM-12	08990-SM-13	08990-SM-14	08990-SM-15

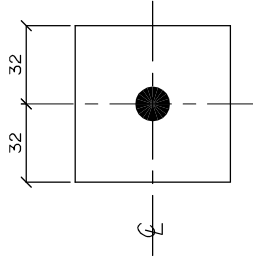

I	CONFORME A CSA S37-18 (CIMA+)	2019/11/28
No	REVISION	DATE

Pêches et Océans
 Canada

Garde côtière
 Coast Guard



STEEL TOWERS / TOURS D'ACIER	
MATERIAL: MATÉRIEL: G40.21M	HOLES: TROUS: 9/16"φ
DRAWN: DESSIN: M.VACHON	CHECKED: VÉRIFIÉ: M.VACHON
SCALE: ÉCHELLE: 1 = 2	FINISH: FINI: GALV.
	DATE: 2005/12/14
	DRAWING: DESSIN: P078

QTY	MRK	DESCRIPTION	LENGTH	GRADE	REMARK	WEIGHT	QTY	MRK	DESCRIPTION	LENGTH	GRADE	REMARK	WEIGHT
QT	MQE	DESCRIPTION	LONG.	NUANCE	REMARQUE	MASSE	QT	MQE	DESCRIPTION	LONG.	NUANCE	REMARQUE	MASSE
1	P078	FB 16.35 X 64	64	300W		0.2							

WEIGHT / MASSE: 0.2 Kg

HEIGHT OF TOWER / HAUTEUR DE LA TOUR	10'	15'	20'	25'	30'	35'	40'	45'	50'	55'	60'	65'	70'	75'	80'
QUANTITY REQUIRED / QUANTITÉ REQUISE	0	0	0	2	2	2	2	2	2	2	2	0	0	0	0
ERECTION DRAWING / DESSIN DE MONTAGE	08990-SM-01	08990-SM-02	08990-SM-03	08990-SM-04	08990-SM-05	08990-SM-06	08990-SM-07	08990-SM-08	08990-SM-09	08990-SM-10	08990-SM-11	08990-SM-12	08990-SM-13	08990-SM-14	08990-SM-15

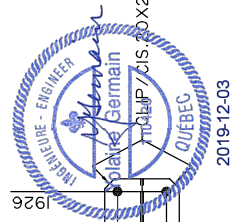
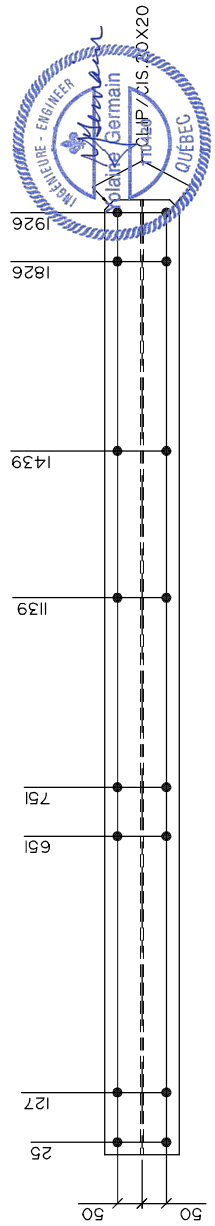
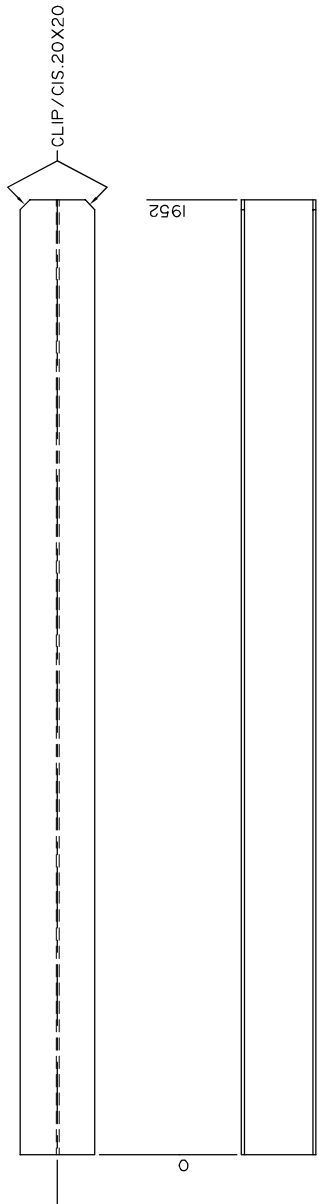

No	REVISION	DATE
I	CONFORME A CSA S37-18 (CIMA+)	2019/11/28

Pêches et Océans
 Canada
 Gardie côtière
 Coast Guard

DESSIN MICHEL VACHON INC.
 DESSIN DES STRUCTURES EN ACIER
 1100, rue de la Vallée
 1^{er} étage, Québec, Québec G1R 5K6

STEEL TOWERS / TOURS D'ACIER	
MATERIAL / MATÉRIEL	G40.21M
HOLES / TROUS	9/16" φ
FINISH / FINI	GALV.
DRAWN / DESSINÉ	M. VACHON
CHECKED / VÉRIFIÉ	M. VACHON
DATE	2005/12/14
SCALE / ÉCHELLE	1 = 10
FILE / DOSSIER	08990-SA
DRAWING / DESSIN	ROT9

QTY	MRK	DESCRIPTION	LENGTH	GRADE	REMARK	WEIGHT	REMARK	LENGTH	GRADE	REMARK	WEIGHT
QT	MQE	DESCRIPTION	LONG.	NUANCE	REMARQUE	MASSE	REMARQUE	LONG.	NUANCE	REMARQUE	MASSE
I	ROT9	W 150 X 22	1952	350W	CLIP / CIS.	45.0					

HEIGHT OF TOWER / HAUTEUR DE LA TOUR	10'	15'	20'	25'	30'	35'	40'	45'	50'	55'	60'	65'	70'	75'	80'
QUANTITY REQUIRED / QUANTITÉ REQUISE	0	0	0	0	0	0	0	0	0	0	0	2	2	2	2
ERECTION DRAWING / DESSIN DE MONTAGE	08990-SM-01	08990-SM-02	08990-SM-03	08990-SM-04	08990-SM-05	08990-SM-06	08990-SM-07	08990-SM-08	08990-SM-09	08990-SM-10	08990-SM-11	08990-SM-12	08990-SM-13	08990-SM-14	08990-SM-15

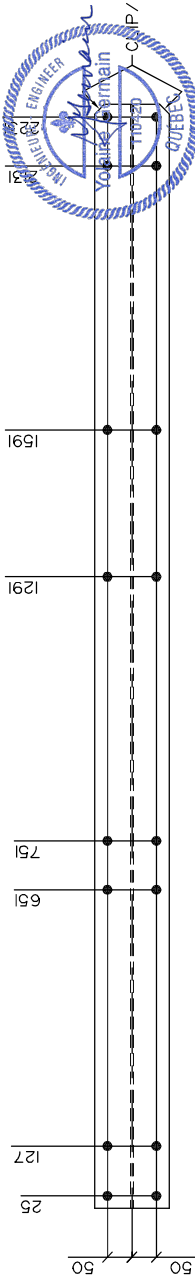
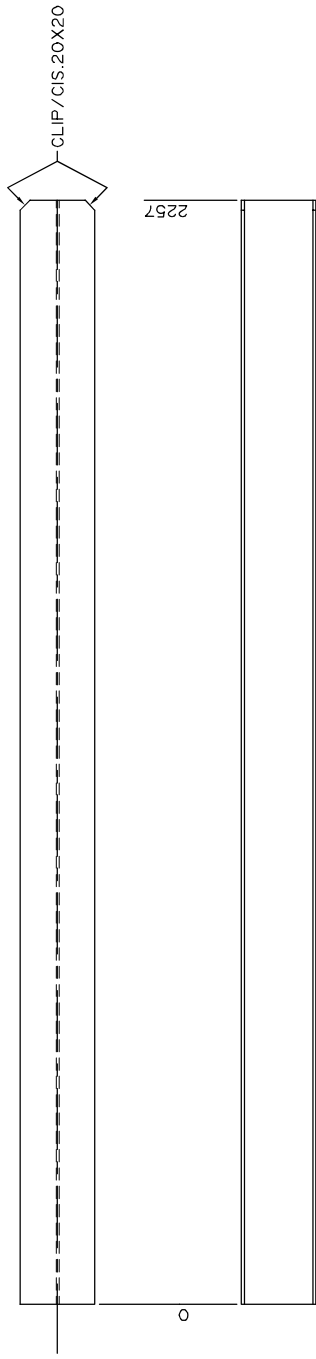

Y.A. BERGMANN
 70179383
 LICENSED PROFESSIONAL ENGINEER
 PROVINCE OF ONTARIO

Y. GAGNON
 10101
 INGENIEUR
 QUÉBEC

2019-12-03
 IP / CIS. 20X20

I	CONFORME A CSA S37-18 (CIMA+)	2019/11/28
No	REVISION	DATE
	Pêches et Océans Canada Fisheries and Oceans Canada	
	Garde côtière	Coast Guard

DESSIN MICHEL VACHON INC. DESSIN DES STRUCTURES EN ACIER 11-PROVINCIAL, 1000-1000 1 ^e COMPLEXE, 1000-1000	
STEEL TOWERS / TOURS D'ACIER	
MATERIAL / MATÉRIEL	G40.21M
HOLES / TROUS	9/16" φ
UN. FINISH / S.N. FINI	GALV.
DRAWN / DESSINÉ	M. VACHON
CHECKED / VÉRIFIÉ	M. VACHON
DATE	2005/12/14
SCALE / ÉCHELLE	1 = 10
FILE / DOSSIER	08990-SA
DRAWING / DESSIN	ROBO

QTY	MRK	DESCRIPTION	LENGTH	GRADE	REMARK	WEIGHT	MRK	DESCRIPTION	LENGTH	GRADE	REMARK	WEIGHT
QT	MQE	DESCRIPTION	LONG.	NUANCE	REMARQUE	MASSE	MQE	DESCRIPTION	LONG.	NUANCE	REMARQUE	MASSE
1	ROBO	W 150 X 22	2257	350W	CLIP / CIS.	52.1						

HEIGHT OF TOWER / HAUTEUR DE LA TOUR	10'	15'	20'	25'	30'	35'	40'	45'	50'	55'	60'	65'	70'	75'	80'
QUANTITY REQUIRED / QUANTIT REQUISE	1	2	3	4	5	6	7	8	9	10	11	12	13	14	15
ERECTION DRAWING / DESSIN DE MONTAGE	08890-SM-01	08890-SM-02	08890-SM-03	08890-SM-04	08890-SM-05	08890-SM-06	08890-SM-07	08890-SM-08	08890-SM-09	08890-SM-10	08890-SM-11	08890-SM-12	08890-SM-13	08890-SM-14	08890-SM-15

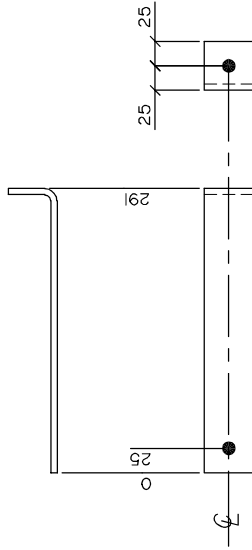

2	CONFORME A CSA S37-18 (CIMA+)	2019/11/28
1	NOUVELLE DESIGNATION	2006/01/19
No	REVISION	DATE

 Pêches et Océans
 Canada
 Garder côte à côte
 Coast Guard

QTY	MRK	DESCRIPTION	LENGTH	GRADE	REMARK	WEIGHT	QTY	MRK	DESCRIPTION	LENGTH	GRADE	REMARK	WEIGHT
QT	MQE	DESCRIPTION	LONG.	NUANCE	REMARQUE	MASSE	QT	MQE	DESCRIPTION	LONG.	NUANCE	REMARQUE	MASSE
1	E081	FB 6.35 X 51	331	300W		0.9							
WEIGHT / MASSE: 0.9 Kg													
STEEL TOWERS / TOURS D'ACIER													
MATERIAL: G40.21M HOLES: 9/16" Ø U.N. FINISH: GALV. PROGS: 1 FINI: GALV. DESIGNED BY: M.VACHON VERIFIED: M.VACHON DATE: 2005/12/14 DRAWING: SCALE: 1 = 5 FILE: 08890-SA DRAWING: E081 DESSIN:													

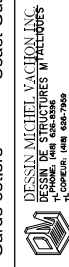

HEIGHT OF TOWER / HAUTEUR DE LA TOUR	10'	15'	20'	25'	30'	35'	40'	45'	50'	55'	60'	65'	70'	75'	80'
QUANTITY REQUIRED / QUANTITÉ REQUISE	1	1	1	1	1	1	1	1	1	1	1	2	2	2	2
ERECTION DRAWING / DESSIN DE MONTAGE	08990-SM-01	08990-SM-02	08990-SM-03	08990-SM-04	08990-SM-05	08990-SM-06	08990-SM-07	08990-SM-08	08990-SM-09	08990-SM-10	08990-SM-11	08990-SM-12	08990-SM-13	08990-SM-14	08990-SM-15

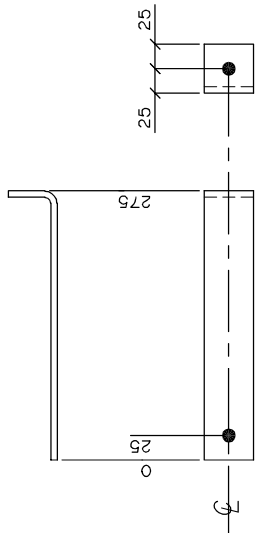

2	CONFORME A CSA S37-18 (CIMA+)	2019/11/28
1	NOUVELLE DESIGNATION	2006/01/19
No	REVISION	DATE

Pêches et Océans
 Canada
 Gardes côtières
 Coast Guard

DESSIN MICHEL VACHON INC.
 DESSIN DES STRUCTURES METALLIQUES
 1-COPELIC, TEL: 506-7900

STEEL TOWERS / TOURS D'ACIER	
MATERIAL: GALV.	U.N. FINISH: GALV.
PROFILES: 9/16" φ	S.N. FIN: GALV.
DESIGN: M.VACHON	DATE: 2005/12/14
SCALE: 1 = 5	FILE: 08990-SA
	DRAWING: E084
	DESSIN: E084

QTY	MRK	DESCRIPTION	LENGTH	GRADE	REMARK	WEIGHT	QTY	MRK	DESCRIPTION	LENGTH	GRADE	REMARK	WEIGHT
QT	MOE	DESCRIPTION	LONG.	NUANCE	REMARQUE	MASSE	QT	MOE	DESCRIPTION	LONG.	NUANCE	REMARQUE	MASSE
1	E084	FB 6.35 X 51	315	300W		0.8							

WEIGHT / MASSE: 0.8 Kg

HEIGHT OF TOWER / HAUTEUR DE LA TOUR	10'	15'	20'	25'	30'	35'	40'	45'	50'	55'	60'	65'	70'	75'	80'
QUANTITY REQUIRED / QUANTIT REQUISE	0	0	0	0	0	0	0	0	0	0	0	0	0	0	0
ERECTION DRAWING / DESSIN DE MONTAGE	08890-SM-01	08890-SM-02	08890-SM-03	08890-SM-04	08890-SM-05	08890-SM-06	08890-SM-07	08890-SM-08	08890-SM-09	08890-SM-10	08890-SM-11	08890-SM-12	08890-SM-13	08890-SM-14	08890-SM-15

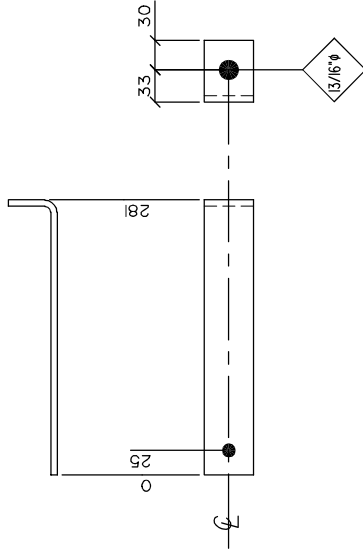

2	CONFORME A CSA S37-18 (CIMA+)	2019/11/28
1	NOUVELLE DESIGNATION	2006/01/19
No	REVISION	DATE

 Pêches et Océans
 Fisheries and Oceans
 Canada

Garde côtière
Coast Guard



STEEL TOWERS / TOURS D'ACIER	
MATERIAL: G40.21M	HOLES: 9/16" φ
DESIGN: M.VACHON	U.N. FINISH: GALV.
DATE: 2005/12/14	FILE: 08890-SA
SCALE: 1 = 5	DRAWING: E085

QTY	MRK	DESCRIPTION	LENGTH	GRADE	REMARK	WEIGHT	QTY	MRK	DESCRIPTION	LENGTH	GRADE	REMARK	WEIGHT
QT	MQE	DESCRIPTION	LONG.	NUANCE	REMARQUE	MASSE	QT	MQE	DESCRIPTION	LONG.	NUANCE	REMARQUE	MASSE
1	E085	FB 6.35 X 51	334	300W		0.9							

WEIGHT / MASSE: 0.9 Kg

HEIGHT OF TOWER / HAUTEUR DE LA TOUR	10'	15'	20'	25'	30'	35'	40'	45'	50'	55'	60'	65'	70'	75'	80'
QUANTITY REQUIRED / QUANTIT REQUISE	1	1	1	1	1	1	1	1	1	1	1	1	1	1	1
ERECTION DRAWING / DESSIN DE MONTAGE	08990-SM-01	08990-SM-02	08990-SM-03	08990-SM-04	08990-SM-05	08990-SM-06	08990-SM-07	08990-SM-08	08990-SM-09	08990-SM-10	08990-SM-11	08990-SM-12	08990-SM-13	08990-SM-14	08990-SM-15

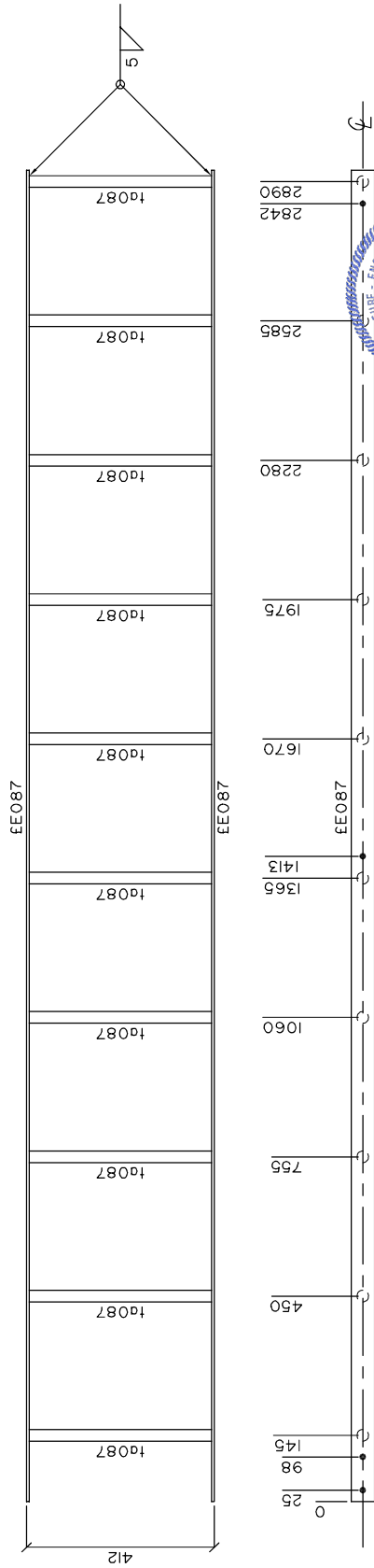

No	1	CONFORME A CSA S37-18 (CIMA+)	2019/11/28
REVISION			DATE
		Pêches et Océans Canada	Fisheries and Oceans Canada
		Garde côtière	Coast Guard



STEEL TOWERS / TOURS D'ACIER			
MATERIAL / MATERIEL	G40.21M	HOLES / TROUS	9/16" φ
UN. FINISH / S.N. FINI			
DATE: 2005/12/15			
CHECKED / VÉRIFIÉ	M. VACHON	DATE: 2005/12/15	
FILE: 08990-SA		DRAWING: E087	
DOSSIER: 08990-SA		DESSIN: E087	

QTY	MRK	DESCRIPTION	LENGTH	GRADE	REMARK	WEIGHT	QTY	MRK	DESCRIPTION	LENGTH	GRADE	WEIGHT / MASSE:	
												REMARK	WEIGHT
QT	MQE	DESCRPTION	LONG.	NUANCE	REMARQUE	MASSE	QT	MQE	DESCRPTION	LONG.	NUANCE	REMARQUE	MASSE
2	E087	FB 6.35 X 51	2915	300W		15.3							
10	t087	● 25.4 φ X 399	399	300W	ASS. E087	16.4							

HEIGHT OF TOWER / HAUTEUR DE LA TOUR	10'	15'	20'	25'	30'	35'	40'	45'	50'	55'	60'	65'	70'	75'	80'
QUANTITY REQUIRED / QUANTIT REQUISE	0	0	1	1	2	2	3	3	4	4	5	5	6	6	7
ERECTION DRAWING / DESSIN DE MONTAGE	08990-SM-01	08990-SM-02	08990-SM-03	08990-SM-04	08990-SM-05	08990-SM-06	08990-SM-07	08990-SM-08	08990-SM-09	08990-SM-10	08990-SM-11	08990-SM-12	08990-SM-13	08990-SM-14	08990-SM-15

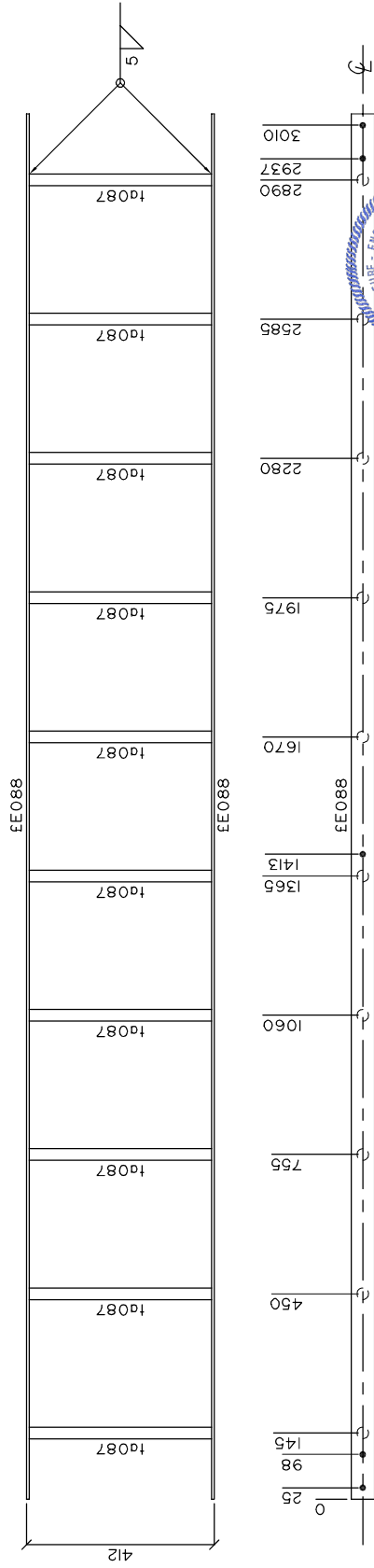

No	CONFORME A CSA S37-18 (CIMA+)	2019/11/28
REVISION		DATE
	Pêches et Océans Canada	Fisheries and Oceans Canada
	Garde côtière	Coast Guard



STEEL TOWERS / TOURS D'ACIER	
MATERIAL / MATERIEL	G40.21M
HOLES / TROUS	9/16" φ
FINISH / FINI	GALV.
CHECKED / VÉRIFIÉ	M.VACHON
DATE	2005/12/15
FILE / DOSSIER	08990-SA
DRAWING / DESSIN	E088

QTY	MRK	DESCRIPTION	LENGTH	GRADE	REMARK	WEIGHT	MRK	DESCRIPTION	LENGTH	GRADE	REMARK	WEIGHT
QT	MQE	DESCRIPTION	LONG.	NUANCE	REMARQUE	MASSE	MQE	DESCRIPTION	LONG.	NUANCE	REMARQUE	MASSE
2	E088	FB 6.35 X 51	3035	300W		15.9						
10	t087	● 25.4 φ X 51	399	300W	ASS. E088	16.4						
WEIGHT / MASSE: 32.3 Kg												

HEIGHT OF TOWER / HAUTEUR DE LA TOUR	10'	15'	20'	25'	30'	35'	40'	45'	50'	55'	60'	65'	70'	75'	80'
QUANTITY REQUIRED / QUANTIT REQUISE	1	1	1	1	1	1	1	1	1	1	1	0	0	0	0
ERECTION DRAWING / DESSIN DE MONTAGE	08990-SM-01	08990-SM-02	08990-SM-03	08990-SM-04	08990-SM-05	08990-SM-06	08990-SM-07	08990-SM-08	08990-SM-09	08990-SM-10	08990-SM-11	08990-SM-12	08990-SM-13	08990-SM-14	08990-SM-15

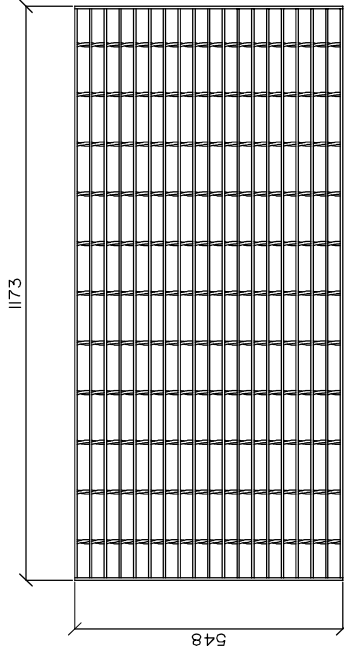

I	CONFORME A CSA S37-18 (CIMA+)	2019/11/28
No	REVISION	DATE
	Pêches et Océans Canada Garde côtière Coast Guard	Fisheries and Oceans Canada

DESSIN MICHEL VACHON INC. DESSIN DES STRUCTURES EN ACIER 1100, rue de la Vallée, Québec, Québec H2L 2K6 Tél: (514) 382-9988	
STEEL TOWERS / TOURS D'ACIER	
MATERIAL / MATÉRIEL	G40.21M
UN. / FINISH	S.N. FINI GALV.
HOLES / TROUS	
CHECKED / VÉRIFIÉ	M. VACHON
DATE	2005/12/15
FILE / DOSSIER	08990-SA
DRAWING / DESSIN	PO90

QTY	MRK	DESCRIPTION	LENGTH	GRADE	REMARK	WEIGHT	MRK	DESCRIPTION	LENGTH	GRADE	REMARK	WEIGHT
QT	MQE	DESCRIPTION	LONG.	NUANCE	REMARQUE	MASSE	MQE	DESCRIPTION	LONG.	NUANCE	REMARQUE	MASSE
1	PO90	GRA. 4.76	31.8	548	1173	30-102	SERRATED/DENTEL	28.8				

WEIGHT / MASSE: 28.8 Kg

HEIGHT OF TOWER / HAUTEUR DE LA TOUR	10'	15'	20'	25'	30'	35'	40'	45'	50'	55'	60'	65'	70'	75'	80'
QUANTITY REQUIRED / QUANTIT REQUISE	1	1	1	1	1	1	1	1	1	1	1	0	0	0	0
ERECTION DRAWING / DESSIN DE MONTAGE	08990-SM-01	08990-SM-02	08990-SM-03	08990-SM-04	08990-SM-05	08990-SM-06	08990-SM-07	08990-SM-08	08990-SM-09	08990-SM-10	08990-SM-11	08990-SM-12	08990-SM-13	08990-SM-14	08990-SM-15

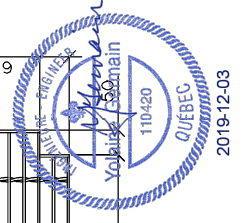
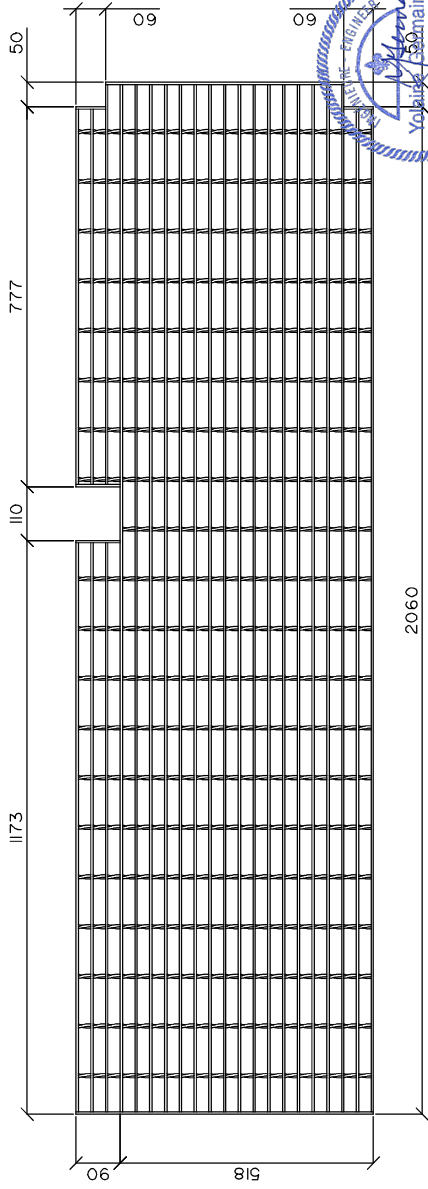

No	CONFORME A CSA S37-18 (CIMA+)	2019/11/28
REVISION		DATE
	Pêches et Océans Canada	Fisheries and Oceans Canada
	Garde côtière	Coast Guard

DESIGN MICHEL VACHON INC. DESIGN DE STRUCTURES ET METALES 11-Comptoir, 1444 1000-7000	
STEEL TOWERS / TOURS D'ACIER	
MATERIAL / MATERIEL	G40.21M
UN. FINISH / S.N. FINI	GALV.
DRAWN / DESSINÉ	M.VACHON
CHECKED / VÉRIFIÉ	M.VACHON
DATE	2005/12/15
FILE / DOSSIER	08990-SA
DRAWING / DESSIN	P091

QTY	MRK	DESCRIPTION	LENGTH	GRADE	REMARK	WEIGHT	GRADE	REMARK	WEIGHT
QT	MQE	DESCRIPTION	LONG.	NUANCE	REMARQUE	MASSE	NUANCE	REMARQUE	MASSE
1	P091	GRA. 4.76 31.8 608	2110	30-102	SERRATED/DENTEL	57.5			
WEIGHT / MASSE: 57.5 Kg									

HEIGHT OF TOWER / HAUTEUR DE LA TOUR	10'	15'	20'	25'	30'	35'	40'	45'	50'	55'	60'	65'	70'	75'	80'
QUANTITY REQUIRED / QUANTIT REQUISE	0	0	0	0	0	0	0	0	0	0	0	0	0	0	0
ERECTION DRAWING / DESSIN DE MONTAGE	08990-SM-01	08990-SM-02	08990-SM-03	08990-SM-04	08990-SM-05	08990-SM-06	08990-SM-07	08990-SM-08	08990-SM-09	08990-SM-10	08990-SM-11	08990-SM-12	08990-SM-13	08990-SM-14	08990-SM-15

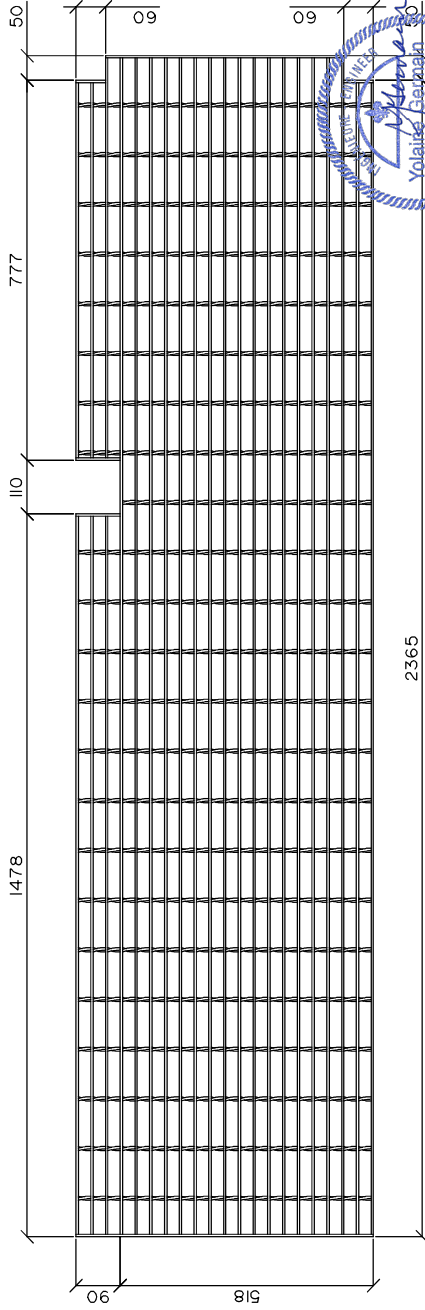

I	CONFORME A CSA S37-18 (CIMA+)	2019/11/28
No	REVISION	DATE
	Pêches et Océans Canada	Fisheries and Oceans Canada
	Garde côtière	Coast Guard



 DESSIN MICHEL VACHON INC.
 DESSIN DES STRUCTURES EN ACIER
 1100, rue de la Paix, 1000-1000

STEEL TOWERS / TOURS D'ACIER	
MATERIAL / MATERIEL	G40.21M
UN. / FINISH	- S.N. FINI
TRAVIS / TROUS	-
DATE: 2005/12/15	
CHECKED: M.VACHON	VERIFIE: M.VACHON
FILE: 08990-SA	DOSSIER: 08990-SA
DRAWING: P092	DESSIN: P092

QTY	MRK	DESCRIPTION	LENGTH	GRADE	REMARK	WEIGHT	DESCRIPTION	MRK	QTY	WEIGHT	REMARK	GRADE	LENGTH	WEIGHT
QT	MQE	DESCRIPTION	LONG.	NUANCE	REMARQUE	MASSE	DESCRIPTION	MQE	QT	MASSE	REMARQUE	NUANCE	LONG.	MASSE
1	P092	GRA. 4.76 31.8 608	2415	30-102	SERRATED/DENTEL	65.8								

WEIGHT / MASSE: 65.8 Kg

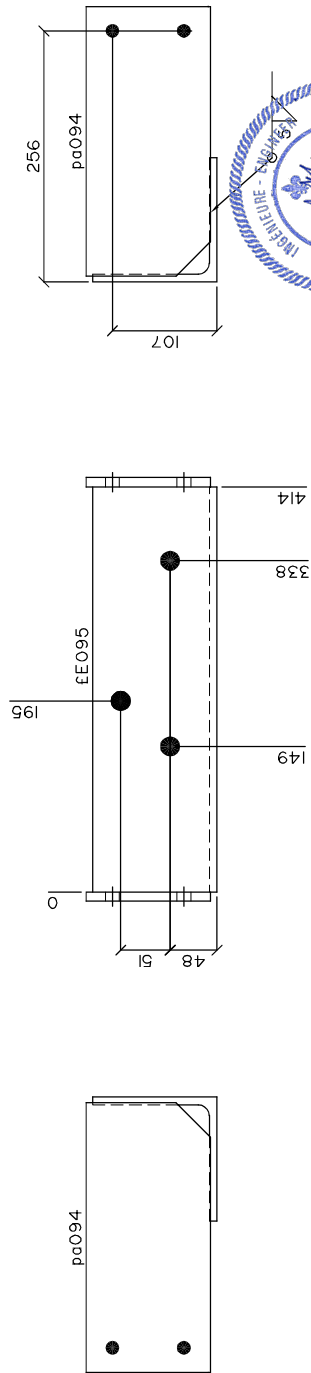
HEIGHT OF TOWER / HAUTEUR DE LA TOUR	10'	15'	20'	25'	30'	35'	40'	45'	50'	55'	60'	65'	70'	75'	80'
QUANTITY REQUIRED / QUANTITE REQUISE	0	0	0	0	0	1	0	0	0	0	0	0	0	0	0
ERECTION DRAWING / DESSIN DE MONTAGE	08990-SM-01	08990-SM-02	08990-SM-03	08990-SM-04	08990-SM-05	08990-SM-06	08990-SM-07	08990-SM-08	08990-SM-09	08990-SM-10	08990-SM-11	08990-SM-12	08990-SM-13	08990-SM-14	08990-SM-15



2020-01-14

2020-01-14

3	CONFORME A CSA S37-18 (CIMA+)	2019/11/28
2	GRADE CHANGED/NUANCE CHANGE	2006/03/22
1	NEW MARK/NOUVELLE MARQUE	2006/01/23
No	REVISION	DATE

Pêches et Océans
Canada
Garde côtière
Coast Guard

DESSIN MICHEL VACHON INC.
DESSIN DES STRUCTURES METALLIQUES
1-COUPON, 1418 838-7500

STEEL TOWERS / TOURS D'ACIER	
MATERIAL: G40.21M	HOLES: 13/16" Ø
FINISH: GALV.	U.N. FINISH: S.N.
DESIGN: M.VACHON	PROJEC. DATE: 2005/12/16
FILE: 08990-SA	DRAWING: E095
DOSSIER: 08990-SA	DESSIN: E095

QTY	MRK	DESCRIPTION	LENGTH	GRADE	REMARK	WEIGHT	MRK	DESCRIPTION	LENGTH	GRADE	REMARK	WEIGHT
QT	MQE	DESCRIPTION	LONG.	NUANCE	REMARQUE	MASSE	MQE	DESCRIPTION	LONG.	NUANCE	REMARQUE	MASSE
1	E095	L 127 127 X	7.94 127	350W	ASS. EE095	6.6						
2	pa094	FB 9.53 X	127 275	300W		5.4						

WEIGHT / MASSE: 12.0 Kg

HEIGHT OF TOWER / HAUTEUR DE LA TOUR		10'	15'	20'	25'	30'	35'	40'	45'	50'	55'	60'	65'	70'	75'	80'
QUANTITY REQUIRED / QUANTIT REQUISE		0	0	0	0	0	0	0	0	0	0	0	0	0	0	0
ERECTION DRAWING / DESSIN DE MONTAGE		08890-SM-01	08890-SM-02	08890-SM-03	08890-SM-04	08890-SM-05	08890-SM-06	08890-SM-07	08890-SM-08	08890-SM-09	08890-SM-10	08890-SM-11	08890-SM-12	08890-SM-13	08890-SM-14	08890-SM-15

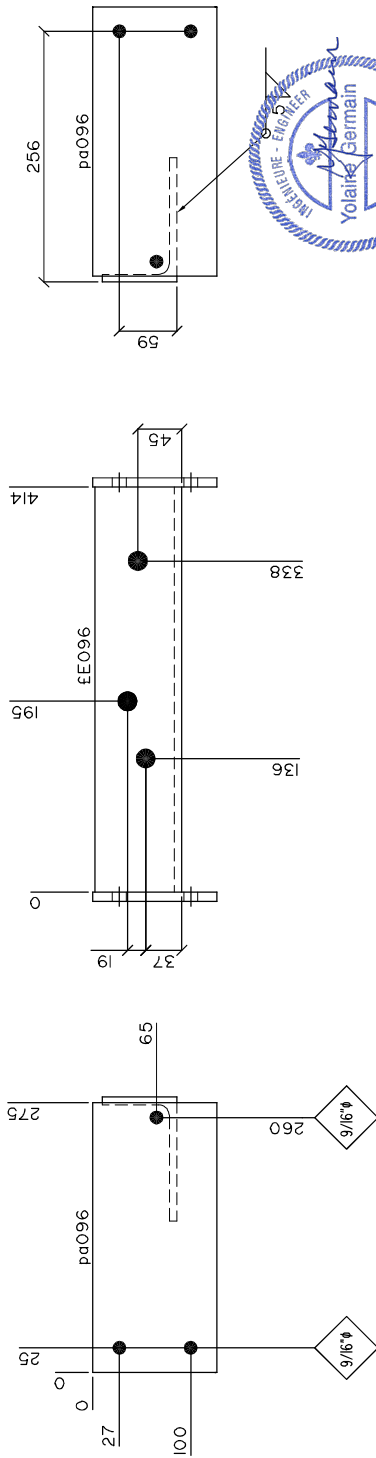

3	QUANTITE REVISEE (CIMA+)	2019/11/28
2	GRADE CHANGED/NUANCE CHANGE	2006/03/22
1	NEW MARK/NOUVELLE MARQUE	2006/01/23
No	REVISION	DATE

Pêches et Océans
 Canada
 Garde côtière
 Coast Guard



STEEL TOWERS / TOURS D'ACIER	
MATERIAL: G40.21M	HOLES: 13/16" Ø
DESIGN: M.VACHON	PROG. S.N.:
DATE: 2005/12/16	FILE: 08890-SA
SCALE: 1 = 5	DRAWING: E096

QTY	MRK	DESCRIPTION	LENGTH	GRADE	REMARK	WEIGHT	MRK	DESCRIPTION	LENGTH	GRADE	REMARK	WEIGHT
QT	MQE	DESCRIPTION	LONG.	NUANCE	REMARQUE	MASSE	MQE	DESCRIPTION	LONG.	NUANCE	REMARQUE	MASSE
1	E096	L 127 89	7.94	350W	ASS. EE096	5.5						
2	pa096	FB 9.53 X	127	300W		5.4						

U.N.	FINISH	GALV.
S.N.	FINI	
DATE:	DATE:	2005/12/16
FILE:	DOSSIER:	08890-SA
DRAWING:	DESSIN:	E096

HEIGHT OF TOWER / HAUTEUR DE LA TOUR		10'	15'	20'	25'	30'	35'	40'	45'	50'	55'	60'	65'	70'	75'	80'
QUANTITY REQUIRED / QUANTIT REQUISE		0	0	0	0	0	0	0	0	0	0	0	0	0	0	0
ERECTION DRAWING / DESSIN DE MONTAGE		08890-SM-01	08890-SM-02	08890-SM-03	08890-SM-04	08890-SM-05	08890-SM-06	08890-SM-07	08890-SM-08	08890-SM-09	08890-SM-10	08890-SM-11	08890-SM-12	08890-SM-13	08890-SM-14	08890-SM-15

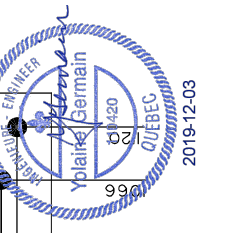
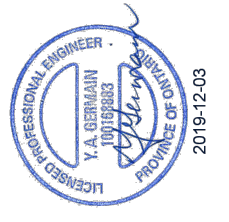
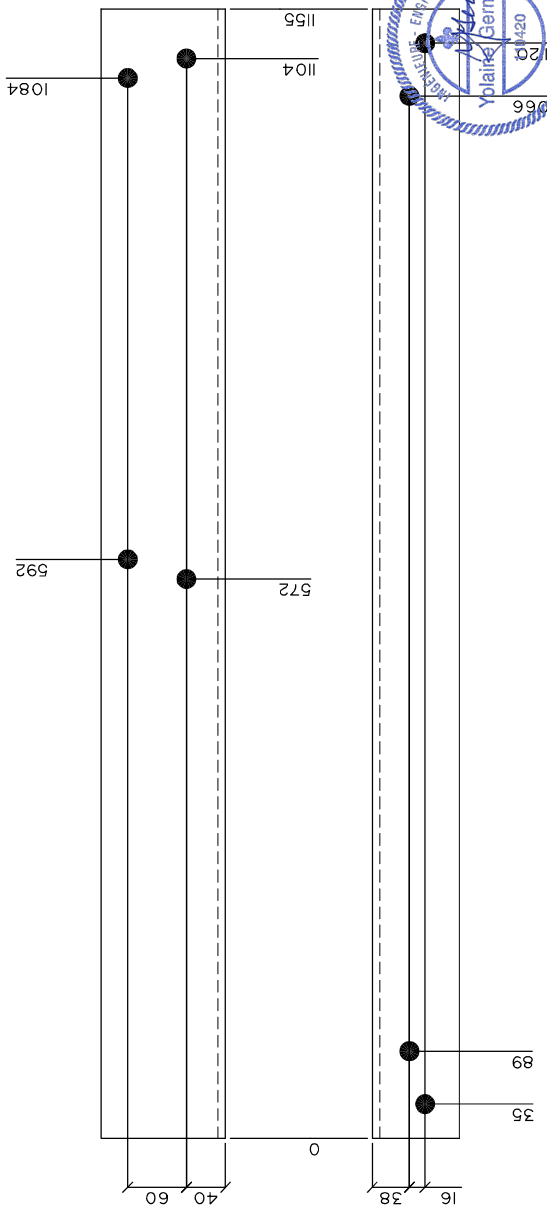

3	CONFORME A CSA S37-18 (CIMA+)	2019/11/28
2	GRADE CHANGED/NUANCE CHANGE	2006/03/22
1	NEW MARK/NOUVELLE MARQUE	2006/01/23
No	REVISION	DATE

Pêches et Océans
 Canada
 Gardes côtières
 Coast Guard



STEEL TOWERS / TOURS D'ACIER
 MATERIAL: G40.21M HOLES: 13/16" Ø U.N. FINISH: GALV.
 PROSS: S.N. FIN: S.N.
 DESIGNED BY: M.VACHON DATE: 2005/12/16
 SCALE: 1 = 5 FILE: 08990-SA DRAWING: E097
 SHEET: 3

QTY	MRK	DESCRIPTION	LENGTH	GRADE	REMARK	WEIGHT	QTY	MRK	DESCRIPTION	LENGTH	GRADE	WEIGHT / MASSE:	
												REMARK	MASSE
1	E097	L 127 89	7.94	1155	350W	15.4							

HEIGHT OF TOWER / HAUTEUR DE LA TOUR	10'	15'	20'	25'	30'	35'	40'	45'	50'	55'	60'	65'	70'	75'	80'
QUANTITY REQUIRED / QUANTIT REQUISE	0	0	0	0	0	0	0	0	0	0	0	0	0	0	0
ERECTION DRAWING / DESSIN DE MONTAGE	08890-SM-01	08890-SM-02	08890-SM-03	08890-SM-04	08890-SM-05	08890-SM-06	08890-SM-07	08890-SM-08	08890-SM-09	08890-SM-10	08890-SM-11	08890-SM-12	08890-SM-13	08890-SM-14	08890-SM-15

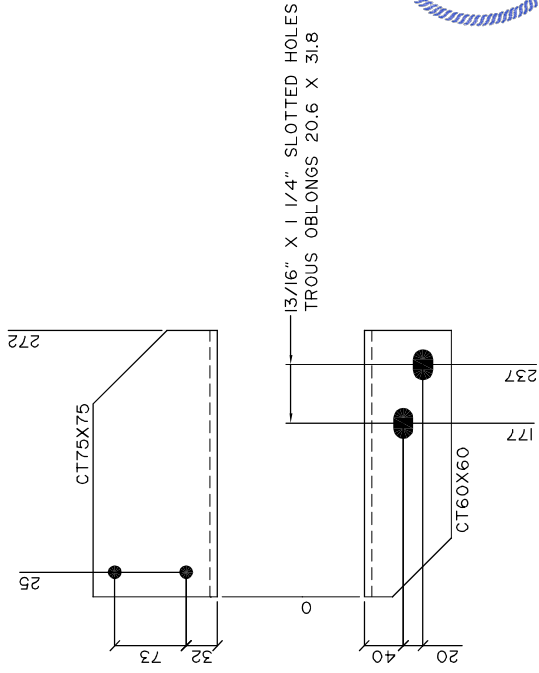

No	REVISION	DATE
3	CONFORME A CSA S37-18 (CIMA+)	2019/11/28
2	GRADE CHANGED/NUANCE CHANGE	2006/03/22
1	NEW MARK/NOUVELLE MARQUE	2006/01/23

Pêches et Océans
 Canada
 Fisheries and Oceans
 Canada

Garde côtière
Coast Guard



STEEL TOWERS / TOURS D'ACIER	
MATERIAL: GALV.	HOLES: 9/16" φ
DESIGN: M.VACHON	U.N. FINISH: GALV.
SCALE: 1 = 5	FILE: 08890-SA
DATE: 2005/12/16	DRIVING: E098

QTY	MRK	DESCRIPTION	LENGTH	GRADE	REMARK	WEIGHT	QTY	MRK	DESCRIPTION	LENGTH	GRADE	REMARK	WEIGHT
QT	MQE	DESCRIPTION	LONG.	NUANCE	REMARQUE	MASSE	QT	MQE	DESCRIPTION	LONG.	NUANCE	REMARQUE	MASSE
1	E098	L 127 89	7.94	272 350W	CLIP / CIS.	3.6							

HEIGHT OF TOWER / HAUTEUR DE LA TOUR	10'	15'	20'	25'	30'	35'	40'	45'	50'	55'	60'	65'	70'	75'	80'
QUANTITY REQUIRED / QUANTIT REQUISE	0	0	0	0	0	0	0	0	0	0	0	0	0	0	0
ERECTION DRAWING / DESSIN DE MONTAGE	08890-SM-01	08890-SM-02	08890-SM-03	08890-SM-04	08890-SM-05	08890-SM-06	08890-SM-07	08890-SM-08	08890-SM-09	08890-SM-10	08890-SM-11	08890-SM-12	08890-SM-13	08890-SM-14	08890-SM-15

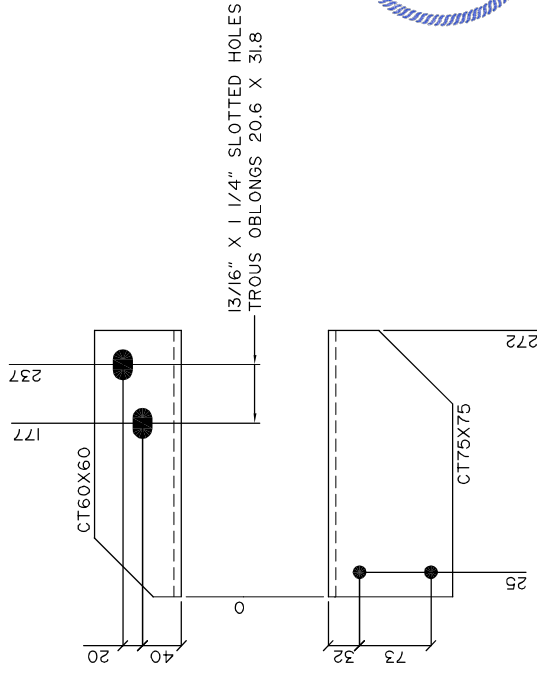

No	REVISION	DATE
3	CONFORME A CSA S37-18 (CIMA+)	2019/11/28
2	GRADE CHANGED/NUANCE CHANGE	2006/03/22
1	NEW MARK/NOUVELLE MARQUE	2006/01/23

Pêches et Océans
 Canada

Garde côtière



STEEL TOWERS / TOURS D'ACIER	
MATERIAL: GALV.	HOLES: 9/16" φ
DESIGN: M.VACHON	PROJEC. DATE: 2005/12/16
SCALE: 1 = 5	FILE: 08990-SA
	DRAWING: E099

QTY	MRK	DESCRIPTION	LENGTH	GRADE	REMARK	WEIGHT	QTY	MRK	DESCRIPTION	LENGTH	GRADE	REMARK	WEIGHT
QT	MQE	DESCRIPTION	LONG.	NUANCE	REMARQUE	MASSE	QT	MQE	DESCRIPTION	LONG.	NUANCE	REMARQUE	MASSE
1	E099	L 127 89	272	350W	CLIP / CIS.	3.6							

WEIGHT / MASSE: 3.6 Kg

HEIGHT OF TOWER / HAUTEUR DE LA TOUR	10'	15'	20'	25'	30'	35'	40'	45'	50'	55'	60'	65'	70'	75'	80'
QUANTITY REQUIRED / QUANTIT REQUISE	0	4	4	8	8	12	12	16	16	20	20	24	24	28	28
ERECTION DRAWING / DESSIN DE MONTAGE	08990-SM-01	08990-SM-02	08990-SM-03	08990-SM-04	08990-SM-05	08990-SM-06	08990-SM-07	08990-SM-08	08990-SM-09	08990-SM-10	08990-SM-11	08990-SM-12	08990-SM-13	08990-SM-14	08990-SM-15

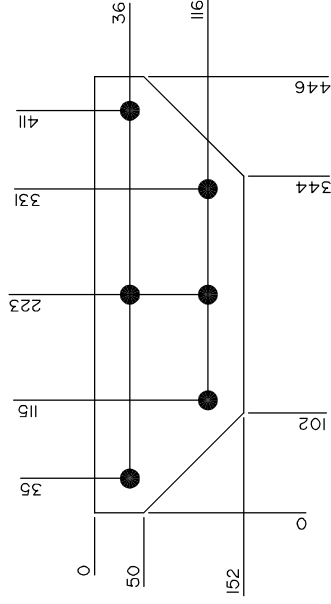

2019-12-03

I	CONFORME A CSA S37-18 (CIMA+)	2019/11/28
No	REVISION	DATE

Pêches et Océans
Canada
Fisheries and Oceans
Canada

Garde côtière
Coast Guard



STEEL TOWERS / TOURS D'ACIER	
MATERIAL: G40.21M	HOLES: 13/16" Ø
U.N. FINISH: GALV.	PROG. S.N.:
DESIGN: M.VACHON	DATE: 2005/12/16
SCALE: 1 = 5	FILE: 08990-SA
DRAWING: MIOO	DESSIN: MIOO

QTY	MRK	DESCRIPTION	LENGTH	GRADE	REMARK	WEIGHT	QTY	DESCRIPTION	LENGTH	GRADE	REMARK	WEIGHT
QT	MQE	DESCRIPTION	LONG.	NUANCE	REMARQUE	MASSE	QT	DESCRIPTION	LONG.	NUANCE	REMARQUE	MASSE
1	MIOO	FB 9.53 X 152	446	300W		4.5						

WEIGHT / MASSE: 4.5 Kg

HEIGHT OF TOWER / HAUTEUR DE LA TOUR	10'	15'	20'	25'	30'	35'	40'	45'	50'	55'	60'	65'	70'	75'	80'
QUANTITY REQUIRED / QUANTIT REQUISE	6	6	6	6	6	6	6	6	6	6	6	0	0	0	0
ERECTION DRAWING / DESSIN DE MONTAGE	08890-SM-01	08890-SM-02	08890-SM-03	08890-SM-04	08890-SM-05	08890-SM-06	08890-SM-07	08890-SM-08	08890-SM-09	08890-SM-10	08890-SM-11	08890-SM-12	08890-SM-13	08890-SM-14	08890-SM-15

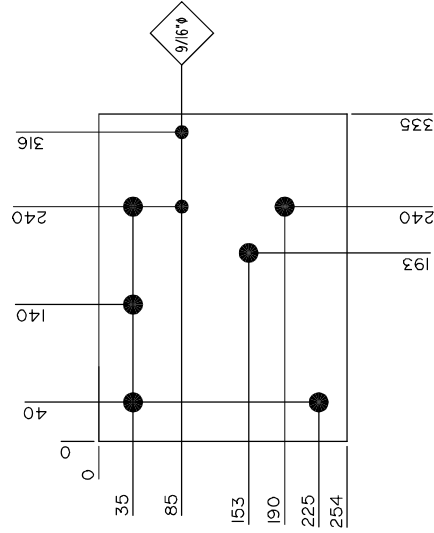

I	CONFORME A CSA S37-18 (CIMA+)	2019/11/28
No	REVISION	DATE

 Pêches et Océans
 Fisheries and Oceans
 Canada

Garde côtière
Coast Guard



QTY	MRK	DESCRIPTION	LENGTH	GRADE	REMARK	WEIGHT	QTY	MRK	DESCRIPTION	LENGTH	GRADE	REMARK	WEIGHT
QT	MQE	DESCRIPTION	LONG.	NUANCE	REMARQUE	MASSE	QT	MQE	DESCRIPTION	LONG.	NUANCE	REMARQUE	MASSE
1	M101	FB 9.53 X 254	335	300W		6.6							
MATERIAL: G40.21M HOLES: 13/16" Ø U.N. FINISH: GALV. PROSS: 13/16" Ø S.N. FINISH: GALV. DESIGNED BY: M.VACHON VERIFIED BY: M.VACHON DATE: 2005/12/16 SCALE: 1 = 5 FILE: 08890-SA DRAWING: M101 SHEET: 1 DESSIN:													

WEIGHT / MASSE: 6.6 KG

HEIGHT OF TOWER / HAUTEUR DE LA TOUR	10'	15'	20'	25'	30'	35'	40'	45'	50'	55'	60'	65'	70'	75'	80'
QUANTITY REQUIRED / QUANTIT REQUISE	7	7	7	7	7	7	7	7	7	7	7	0	0	0	0
ERECTION DRAWING / DESSIN DE MONTAGE	08890-SM-01	08890-SM-02	08890-SM-03	08890-SM-04	08890-SM-05	08890-SM-06	08890-SM-07	08890-SM-08	08890-SM-09	08890-SM-10	08890-SM-11	08890-SM-12	08890-SM-13	08890-SM-14	08890-SM-15

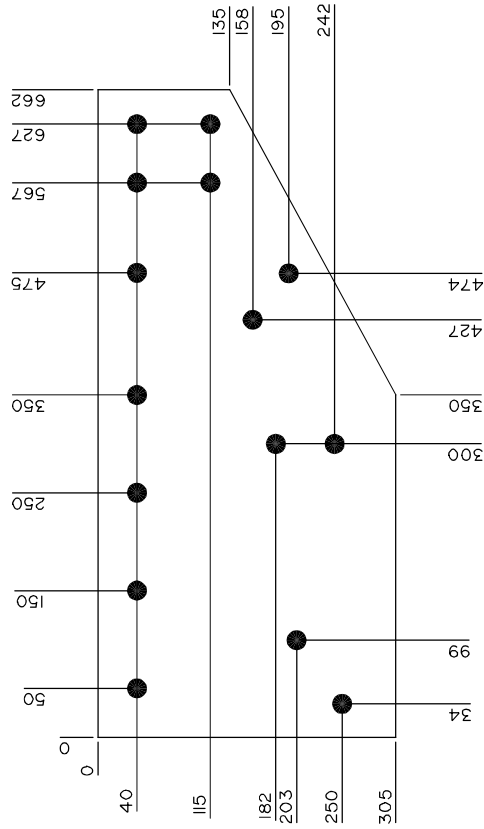

2019-12-03

2019-12-03

I	CONFORME A CSA S37-18 (CIMA+)	2019/11/28
No	REVISION	DATE

Pêches et Océans
Canada

Garde côtière
Coast Guard



STEEL TOWERS / TOURS D'ACIER	
MATERIAL: MATÉRIEL:	G40.21M
HOLES: PROUS:	13/16" Ø
FINISH: FINI:	GALV.
DESIGN: DESSIN:	M.VACHON
DATE: DATE:	2005/12/16
SCALE: ÉCHELLE:	1 = 5
FILE: DOSSIER:	08890-SA
DRAWING: DESSIN:	MIO2

QTY	MRK	DESCRIPTION	LENGTH	GRADE	REMARK	WEIGHT	QTY	MRK	DESCRIPTION	LENGTH	GRADE	REMARK	WEIGHT
QT	MQE	DESCRIPTION	LONG.	NUANCE	REMARQUE	MASSE	QT	MQE	DESCRIPTION	LONG.	NUANCE	REMARQUE	MASSE
1	MIO2	FB 9.53 X 305	662	300W		13.6							

HEIGHT OF TOWER / HAUTEUR DE LA TOUR	15'	20'	25'	30'	35'	40'	45'	50'	55'	60'	65'	70'	75'	80'	
QUANTITY REQUIRED / QUANTIT REQUISE	0	8	16	24	32	36	40	44	48	52	56	60	64	68	
ERECTION DRAWING / DESSIN DE MONTAGE	08990-SM-01	08990-SM-02	08990-SM-03	08990-SM-04	08990-SM-05	08990-SM-06	08990-SM-07	08990-SM-08	08990-SM-09	08990-SM-10	08990-SM-11	08990-SM-12	08990-SM-13	08990-SM-14	08990-SM-15

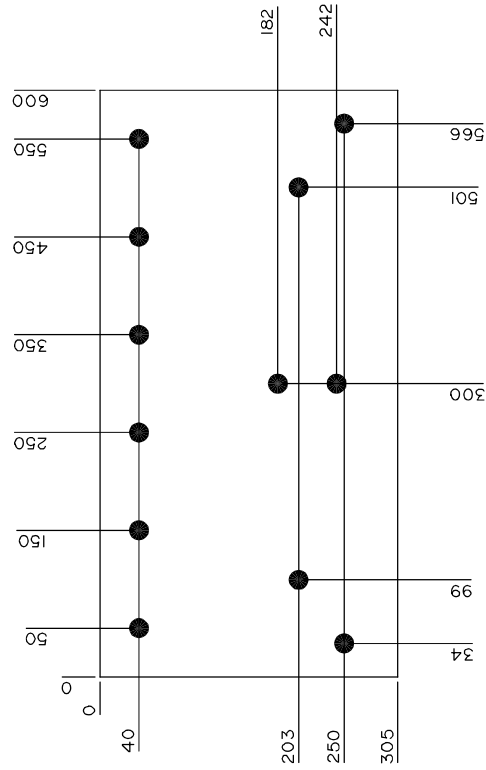

I	QUANTITE	REVISEE (CIMA+)	2019/11/28
No	REVISION		DATE

Pêches et Océans
 Canada
 Fisheries and Oceans
 Canada

Garde côtière
Coast Guard



QTY	MRK	DESCRIPTION	LENGTH	GRADE	REMARK	WEIGHT	GRADE	REMARK	WEIGHT
QT	MQE	DESCRIPTION	LONG.	NUANCE	REMARQUE	MASSE	NUANCE	REMARQUE	MASSE
1	MIO3	FB 9.53 X 305	600	300W		14.2			14.2 Kg

STEEL TOWERS / TOURS D'ACIER
 MATERIAL: G40.21M HOLES: 13/16" Ø U.N. FINISH: GALV.
 PROSS: 1.000 S.N. FINI: GALV.
 DESIGNED BY: M.VACHON VERIFIED: M.VACHON DATE: 2005/12/16
 DRAWING: MIO3
 SHEET: 1 = 5 FILE: 08990-SA DRAWING: MIO3
 DOSSIER: 08990-SA DESSIN: MIO3

HEIGHT OF TOWER / HAUTEUR DE LA TOUR	10'	15'	20'	25'	30'	35'	40'	45'	50'	55'	60'	65'	70'	75'	80'
QUANTITY REQUIRED / QUANTIT. REQUISE	0	0	0	0	0	8	8	8	8	8	8	0	0	0	0
ERECTION DRAWING / DESSIN DE MONTAGE	08990-SM-01	08990-SM-02	08990-SM-03	08990-SM-04	08990-SM-05	08990-SM-06	08990-SM-07	08990-SM-08	08990-SM-09	08990-SM-10	08990-SM-11	08990-SM-12	08990-SM-13	08990-SM-14	08990-SM-15

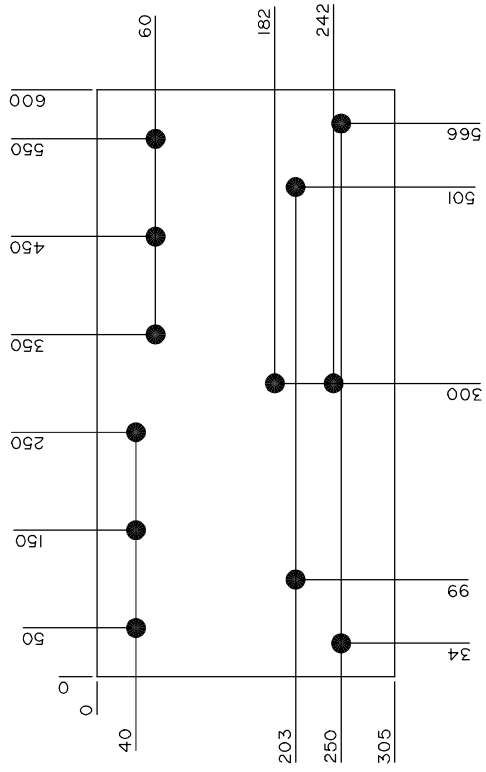

I	CONFORME A CSA S37-18 [CIMA+]	2019/11/28
No	REVISION	DATE
	Pêches et Océans Canada	Fisheries and Oceans Canada
	Garde côtière	Coast Guard
DESSIN MICHEL VACHON INC. DESSIN DES STRUCTURES METALLIQUES 1-COUPON, 448 838-7900		
STEEL TOWERS / TOURS D'ACIER		
MATERIAL:	G40.21M	HOLES: 13/16" Ø
U.N. FINISH:		S.N. GALV.
DESIGNER:	M.VACHON	PROJECTED: M.VACHON
DATE:		2005/12/16
SCALE:	1 = 5	FILE: 08990-SA
DRAWING:		DESSIN: M104

QTY	MRK	DESCRIPTION	LENGTH	GRADE	REMARK	WEIGHT	MRK	DESCRIPTION	LENGTH	GRADE	REMARK	WEIGHT
QT	MQE	DESCRIPTION	LONG.	NUANCE	REMARQUE	MASSE	MQE	DESCRIPTION	LONG.	NUANCE	REMARQUE	MASSE
1	M104	FB 9.53 X 305	600	300W		14.2						

WEIGHT / MASSE: 14.2 Kg

HEIGHT OF TOWER / HAUTEUR DE LA TOUR	10'	15'	20'	25'	30'	35'	40'	45'	50'	55'	60'	65'	70'	75'	80'
QUANTITY REQUIRED / QUANTIT REQUISE	1	1	1	1	1	1	1	1	1	1	1	0	0	0	0
ERECTOR DRAWING / DESSIN DE MONTAGE	08890-SM-01	08890-SM-02	08890-SM-03	08890-SM-04	08890-SM-05	08890-SM-06	08890-SM-07	08890-SM-08	08890-SM-09	08890-SM-10	08890-SM-11	08890-SM-12	08890-SM-13	08890-SM-14	08890-SM-15

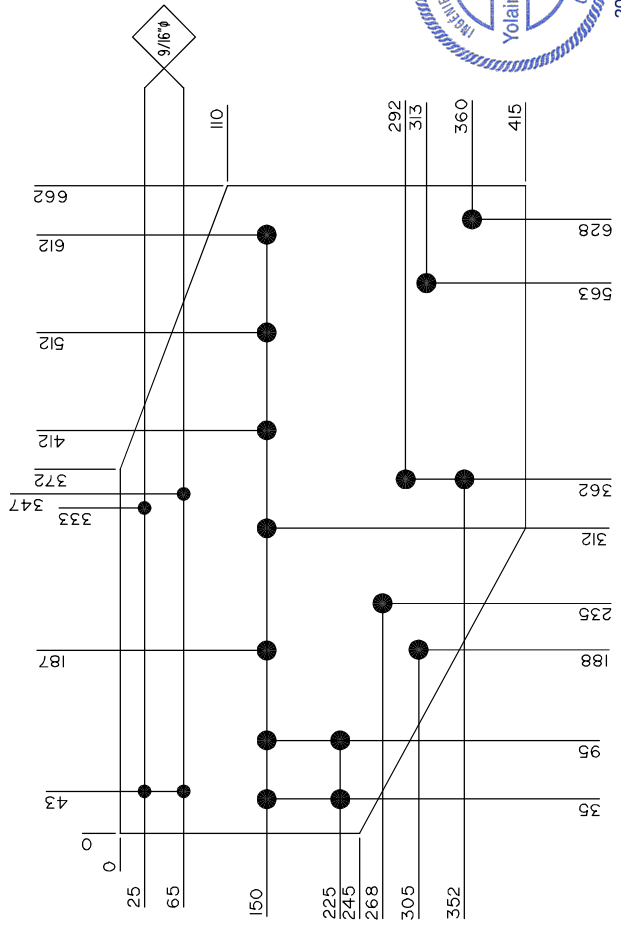

I	CONFORME A CSA S37-18 (CIMA+)	2019/11/28
No	REVISION	DATE

Pêches et Océans
 Canada
 Garde côtière
 Coast Guard



STEEL TOWERS / TOURS D'ACIER	
MATERIAL: GALV.	U.N. FINISH: GALV.
PROSS: M.VACHON	PROS: M.VACHON
DATE: 2005/12/16	DATE: 2005/12/16
SCALE: 1 = 5	FILE: 08890-SA
DRAWING: MIO8	DESSIN: MIO8

QTY	MRK	DESCRIPTION	LENGTH	GRADE	REMARK	WEIGHT	MRK	DESCRIPTION	LENGTH	GRADE	REMARK	WEIGHT
QT	MQE	DESCRIPTION	LONG.	NUANCE	REMARQUE	MASSE	MQE	DESCRIPTION	LONG.	NUANCE	REMARQUE	MASSE
1	MIO8	PL 9.53 X 415	662	300W		18.0						

WEIGHT / MASSE: 18.0 Kg

HEIGHT OF TOWER / HAUTEUR DE LA TOUR	10'	15'	20'	25'	30'	35'	40'	45'	50'	55'	60'	65'	70'	75'	80'
QUANTITY REQUIRED / QUANTIT REQUISE	0	0	0	0	0	0	0	0	0	0	0	6	6	6	6
ERECTION DRAWING / DESSIN DE MONTAGE	08890-SM-01	08890-SM-02	08890-SM-03	08890-SM-04	08890-SM-05	08890-SM-06	08890-SM-07	08890-SM-08	08890-SM-09	08890-SM-10	08890-SM-11	08890-SM-12	08890-SM-13	08890-SM-14	08890-SM-15

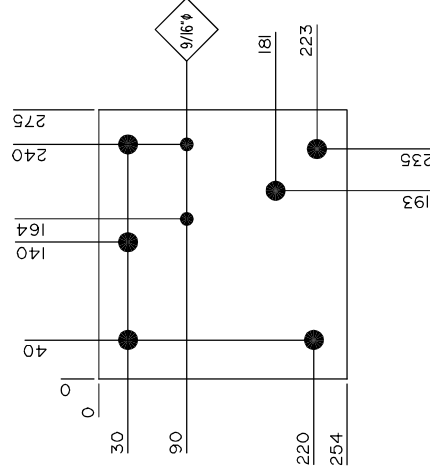

I	CONFORME A CSA S37-18 (CIMA+)	2019/11/28
No	REVISION	DATE

 Pêches et Océans
 Canada
 Gardes côtières
 Coast Guard

DESSIN MICHEL VACHON INC.
 DESSIN DES STRUCTURES METALLIQUES
 1-COULBURN, TEL: 514-730-7900

STEEL TOWERS / TOURS D'ACIER	
MATERIAL: G40.21M	U.N. FINISH: GALV.
PROSS: 13/16"φ	S.N. FIN: 1
DESIGN: M.VACHON	DATE: 2005/12/16
SCALE: 1 = 5	DRAWING: 08890-SA
	DESSIN: M109

QTY	MRK	DESCRIPTION	LENGTH	GRADE	REMARK	WEIGHT	QTY	MRK	DESCRIPTION	LENGTH	GRADE	REMARK	WEIGHT
QT	MQE	DESCRIPTION	LONG.	NUANCE	REMARQUE	MASSE	QT	MQE	DESCRIPTION	LONG.	NUANCE	REMARQUE	MASSE
1	M109	FB 9.53 X 254	275	300W		5.4							

WEIGHT / MASSE: 5.4 Kg

HEIGHT OF TOWER / HAUTEUR DE LA TOUR	10'	15'	20'	25'	30'	35'	40'	45'	50'	55'	60'	65'	70'	75'	80'
QUANTITY REQUIRED / QUANTIT REQUISE	0	0	0	0	0	0	0	0	0	0	0	0	0	0	0
ERECTION DRAWING / DESSIN DE MONTAGE	08990-SM-01	08990-SM-02	08990-SM-03	08990-SM-04	08990-SM-05	08990-SM-06	08990-SM-07	08990-SM-08	08990-SM-09	08990-SM-10	08990-SM-11	08990-SM-12	08990-SM-13	08990-SM-14	08990-SM-15

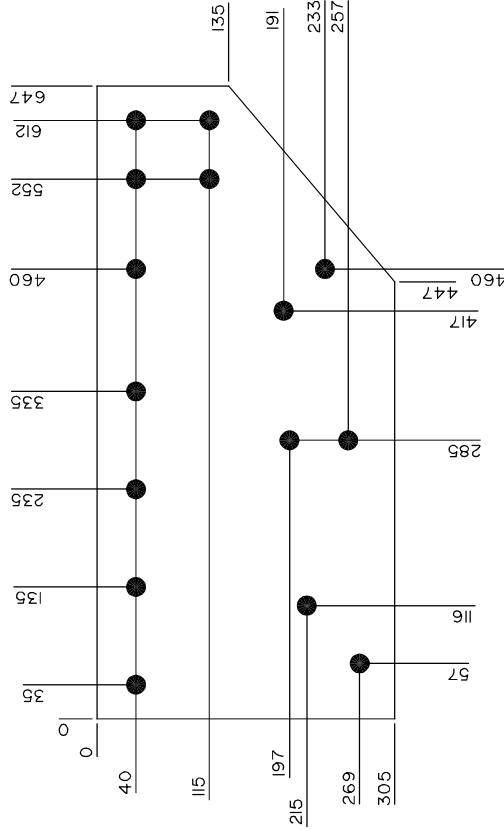

No	REVISION	DATE
I	CONFORME A CSA S37-18 (CIMA+)	2019/11/28

 Pêches et Océans
 Canada
 Garder côte
 Coast Guard



DESSIN MICHEL VACHON INC.
 DESSIN / DRAWING
 1-COPIEUR (449 688-7949)

STEEL TOWERS / TOURS D'ACIER	
MATERIAL: GALV.	U.N. FINISH: GALV.
PROCESSED: M.VACHON	DATE: 2005/12/16
FILE: 08990-SA	DRAWING: MIO
DOSSIER: 1 = 5	DESSIN: MIO

QTY	MRK	DESCRIPTION	LENGTH	GRADE	REMARK	WEIGHT	MRK	DESCRIPTION	LENGTH	GRADE	REMARK	WEIGHT
QT	MQE	DESCRIPTION	LONG.	NUANCE	REMARQUE	MASSE	MQE	DESCRIPTION	LONG.	NUANCE	REMARQUE	MASSE
1	MIO	FB 9.53 X 305	647	300W		13.9						

WEIGHT / MASSE: 13.9 Kg

HEIGHT OF TOWER / HAUTEUR DE LA TOUR	10'	15'	20'	25'	30'	35'	40'	45'	50'	55'	60'	65'	70'	75'	80'
QUANTITY REQUIRED / QUANTIT REQUISE	0	0	0	0	0	0	0	0	0	0	0	16	16	16	16
ERECTION DRAWING / DESSIN DE MONTAGE	08890-SM-01	08890-SM-02	08890-SM-03	08890-SM-04	08890-SM-05	08890-SM-06	08890-SM-07	08890-SM-08	08890-SM-09	08890-SM-10	08890-SM-11	08890-SM-12	08890-SM-13	08890-SM-14	08890-SM-15

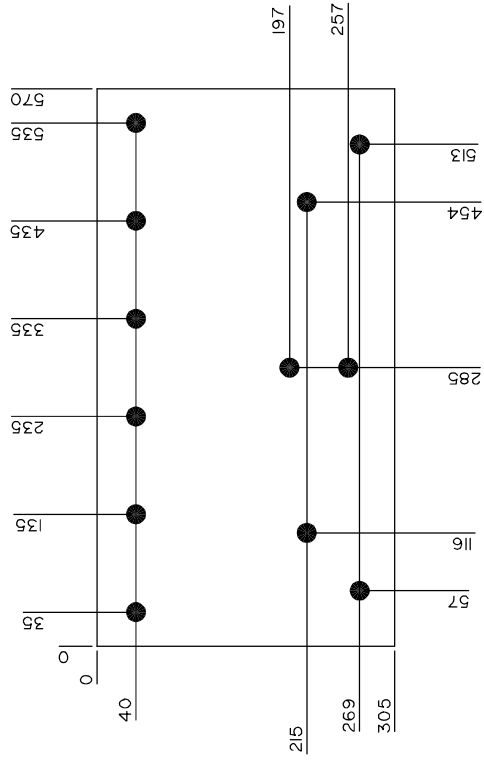

No	QUANTITE REVISEE (CIMA+)	REVISION	DATE
I			2019/11/28

 Pêches et Océans
 Canada
 Fisheries and Oceans
 Canada
 Garde côtière
 Coast Guard



STEEL TOWERS / TOURS D'ACIER	
MATERIAL: MATÉRIEL:	G40.2IM
HOLE: PROUS:	13/16" Ø
U.N. FINISH: FINI:	
S.N. FILE:	
DESIGN: M.VACHON	DATE: 2005/12/17
VERIFIED: M.VACHON	
SCALE: ÉCHELLE:	1 = 5
FILE: DOSSIER:	08990-SA
DRAWING: DESSIN:	MII

QTY	MRK	DESCRIPTION	LENGTH	GRADE	REMARK	WEIGHT	MRK	DESCRIPTION	LENGTH	GRADE	REMARK	WEIGHT
QT	MQE	DESCRIPTION	LONG.	NUANCE	REMARQUE	MASSE	MQE	DESCRIPTION	LONG.	NUANCE	REMARQUE	MASSE
1	MII	FB 9.53 X 305	570	300W		13.4						

WEIGHT / MASSE: 13.4 Kg

HEIGHT OF TOWER / HAUTEUR DE LA TOUR	10'	15'	20'	25'	30'	35'	40'	45'	50'	55'	60'	65'	70'	75'	80'
QUANTITY REQUIRED / QUANTIT REQUISE	0	0	0	0	0	0	0	0	0	0	0	8	8	8	8
ERECTION DRAWING / DESSIN DE MONTAGE	08890-SM-01	08890-SM-02	08890-SM-03	08890-SM-04	08890-SM-05	08890-SM-06	08890-SM-07	08890-SM-08	08890-SM-09	08890-SM-10	08890-SM-11	08890-SM-12	08890-SM-13	08890-SM-14	08890-SM-15

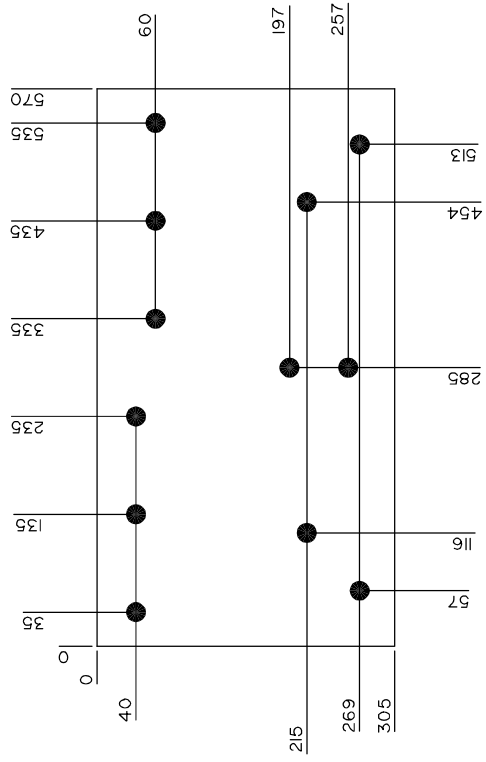

I	CONFORME A CSA S37-18 (CIMA+)	2019/11/28
No	REVISION	DATE

Pêches et Océans
 Canada
 Garder côte à côte
 Coast Guard



STEEL TOWERS / TOURS D'ACIER	
MATERIAL: MATÉRIEL: G40.21M	U.N. FINISH: GALV.
HOLES: 13/16" Ø	S.N. FIN: 1
PROCESSED: M.VACHON	DATE: 2005/12/17
DESIGNED: M.VACHON	FILE: 08990-SA
CHECKED: 1 = 5	DRAWING: MII2
	DESSIN: MII2

QTY	MRK	DESCRIPTION	LENGTH	GRADE	REMARK	WEIGHT	MRK	DESCRIPTION	LENGTH	GRADE	REMARK	WEIGHT
QT	MQE	DESCRIPTION	LONG.	NUANCE	REMARQUE	MASSE	MQE	DESCRIPTION	LONG.	NUANCE	REMARQUE	MASSE
1	MII2	FB 9.53 X 305	570	300W		13.4						

WEIGHT / MASSE: 13.4 Kg

HEIGHT OF TOWER / HAUTEUR DE LA TOUR	10'	15'	20'	25'	30'	35'	40'	45'	50'	55'	60'	65'	70'	75'	80'
QUANTITY REQUIRED / QUANTIT REQUISE	0	0	0	0	0	0	0	0	0	0	0	32	40	40	40
ERECTION DRAWING / DESSIN DE MONTAGE	08890-SM-01	08890-SM-02	08890-SM-03	08890-SM-04	08890-SM-05	08890-SM-06	08890-SM-07	08890-SM-08	08890-SM-09	08890-SM-10	08890-SM-11	08890-SM-12	08890-SM-13	08890-SM-14	08890-SM-15

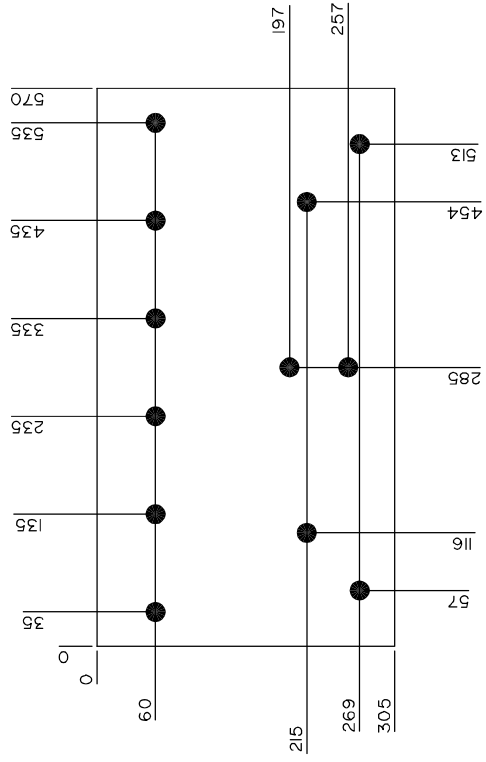

I	QUANTITE	REVISEE (CIMA+)	2019/11/28
No	REVISION		DATE

 Pêches et Océans
 Canada
 Gardie côtière
 Coast Guard



STEEL TOWERS / TOURS D'ACIER	
MATERIAL: G40.21M	UN. FINISH: GALV.
HOLES: 13/16" Ø	S.N. FIN: 2005/12/17
DESIGNER: M.VACHON	DATE: 2005/12/17
SCALE: 1 = 5	DRAWING: 08990-SA
	DESSIN: MII3

QTY	MRK	DESCRIPTION	LENGTH	GRADE	REMARK	WEIGHT	MRK	DESCRIPTION	LENGTH	GRADE	REMARK	WEIGHT
QT	MQE	DESCRIPTION	LONG.	NUANCE	REMARQUE	MASSE	MQE	DESCRIPTION	LONG.	NUANCE	REMARQUE	MASSE
1	MII3	FB 9.53 X 305	570	300W		13.4						

WEIGHT / MASSE: 13.4 Kg

HEIGHT OF TOWER / HAUTEUR DE LA TOUR	10'	15'	20'	25'	30'	35'	40'	45'	50'	55'	60'	65'	70'	75'	80'
QUANTITY REQUIRED / QUANTIT REQUISE	0	0	0	0	0	0	0	0	0	0	0	0	0	0	0
ERECTION DRAWING / DESSIN DE MONTAGE	08990-SM-01	08990-SM-02	08990-SM-03	08990-SM-04	08990-SM-05	08990-SM-06	08990-SM-07	08990-SM-08	08990-SM-09	08990-SM-10	08990-SM-11	08990-SM-12	08990-SM-13	08990-SM-14	08990-SM-15

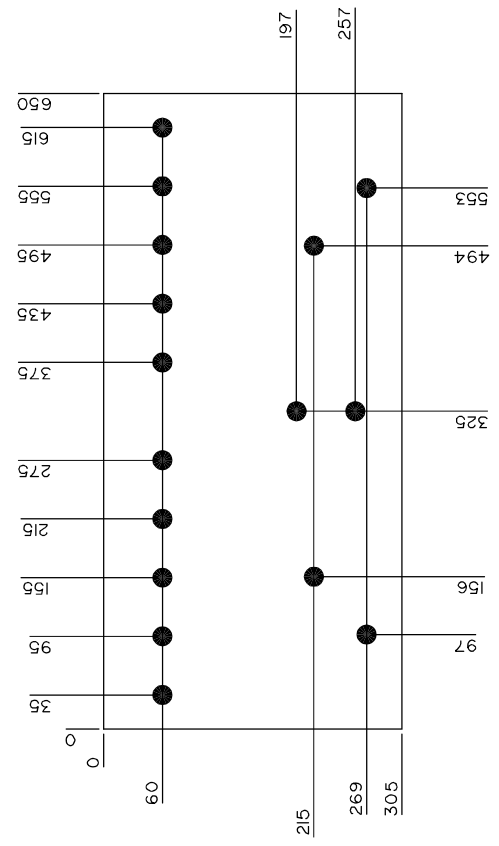

I	EPAISSEUR	PLAQUE	REVISEE	[CIMA+]	2019/11/28
No	REVISION	Pêches et Océans Canada		Fisheries and Oceans Canada	DATE
			Garde côtière	Coast Guard	



STEEL TOWERS / TOURS D'ACIER	
MATERIAL: MATERIEL:	G40.21M
HOLES: TROUS:	13/16" Ø
FINISH: FINI:	GALV.
DRAWN: DESSINÉ:	M. VACHON
CHECKED: VÉRIFIÉ:	M. VACHON
DATE: DATE:	2005/12/17
SCALE: ÉCHELLE:	1 = 5
FILE: DOSSIER:	08990-SA
DRAWING: DESSIN:	MI15

QTY	MRK	DESCRIPTION	LENGTH	GRADE	REMARK	WEIGHT	QTY	MRK	DESCRIPTION	LENGTH	GRADE	REMARK	WEIGHT
QT	MQE	DESCRIPTION	LONG.	NUANCE	REMARQUE	MASSE	QT	MQE	DESCRIPTION	LONG.	NUANCE	REMARQUE	MASSE
1	MI15	FB 12,7 X 305	650	300W		20.2							

HEIGHT OF TOWER / HAUTEUR DE LA TOUR	10'	15'	20'	25'	30'	35'	40'	45'	50'	55'	60'	65'	70'	75'	80'
QUANTITY REQUIRED / QUANTITÉ REQUISE	0	0	0	0	0	0	0	0	0	0	0	8	8	16	24
ERECTION DRAWING / DESSIN DE MONTAGE	08990-SM-01	08990-SM-02	08990-SM-03	08990-SM-04	08990-SM-05	08990-SM-06	08990-SM-07	08990-SM-08	08990-SM-09	08990-SM-10	08990-SM-11	08990-SM-12	08990-SM-13	08990-SM-14	08990-SM-15

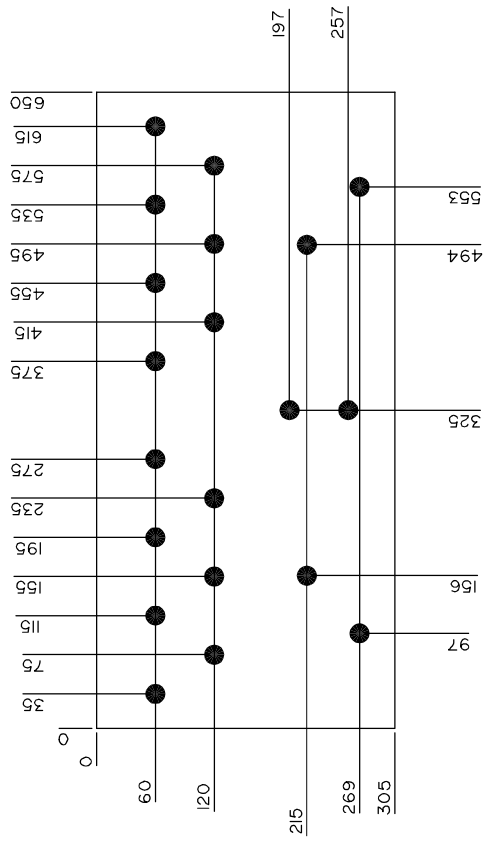

I	EPAISSEUR PLAQUE ET QUANTITE REVISÉES (CIMA+)	2019/11/28
No	REVISION	DATE

Pêches et Océans
 Canada
 Fisheries and Oceans
 Canada
 Garde côtière
 Coast Guard



STEEL TOWERS / TOURS D'ACIER
 MATERIAL: G40.21M U.N. FINISH: GALV.
 MATÉRIEL: G40.21M TROUS: 13/16" Ø S.N. FINI: GALV.
 DRAWN: M.VACHON CHECKED: M.VACHON DATE: 2005/12/17
 DESSIN: M.VACHON DATE: 2005/12/17
 SCALE: 1 = 5 LE DOSSIER: 08990-SA DRAWING: MI17

QTY	MRK	DESCRIPTION	LENGTH	GRADE	REMARK	WEIGHT	QTY	MRK	DESCRIPTION	LENGTH	GRADE	REMARK	WEIGHT
QT	MQE	DESCRIPTION	LONG.	NUANCE	REMARQUE	MASSE	QT	MQE	DESCRIPTION	LONG.	NUANCE	REMARQUE	MASSE
1	MI17	FB 15.9 X 305	650	300W		24.9							

WEIGHT / MASSE: 24.9 Kg

HEIGHT OF TOWER / HAUTEUR DE LA TOUR	10'	15'	20'	25'	30'	35'	40'	45'	50'	55'	60'	65'	70'	75'	80'
QUANTITY REQUIRED / QUANTIT REQUISE	0	0	0	0	0	0	0	0	0	0	0	0	0	0	0
ERECTION DRAWING / DESSIN DE MONTAGE	08890-SM-01	08890-SM-02	08890-SM-03	08890-SM-04	08890-SM-05	08890-SM-06	08890-SM-07	08890-SM-08	08890-SM-09	08890-SM-10	08890-SM-11	08890-SM-12	08890-SM-13	08890-SM-14	08890-SM-15

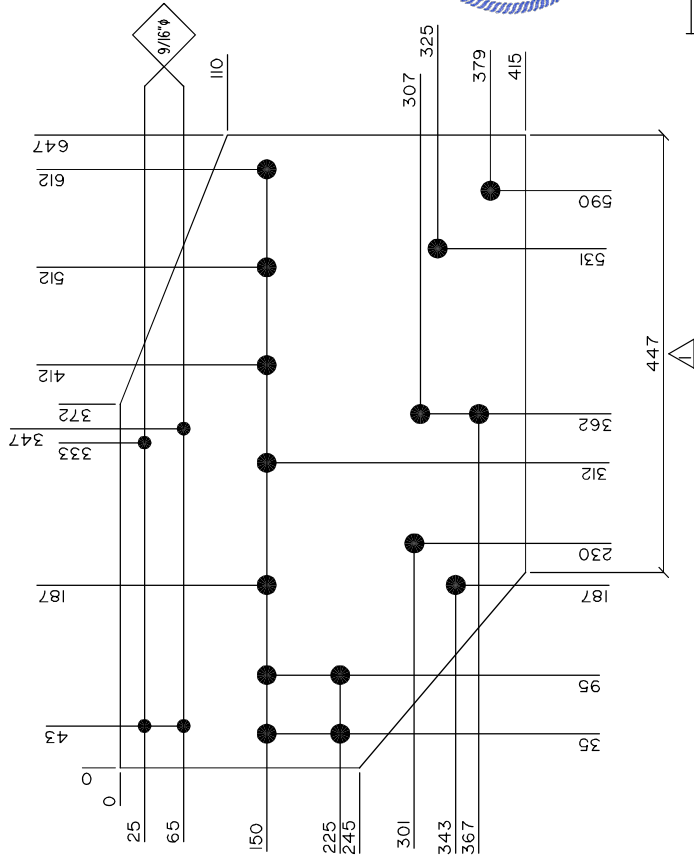

2	CONFORME A CSA S37-18 (CIMA+)	2019/11/28
1	AJOUT DIMENSION	2014-09-24
No	REVISION	DATE

Pêches et Océans
 Canada
 Garder coteière
 Coast Guard



STEEL TOWERS / TOURS D'ACIER	
MATERIAL: GALV.	UN. FINISH: GALV.
PROCES: M.VACHON	PROCES: M.VACHON
DESIGN: M.VACHON	DATE: 2005/12/17
SCALE: 1 = 5	DRAWING: 08990-SA
	DESSIN: MI18

QTY	MRK	DESCRIPTION	LENGTH	GRADE	REMARK	WEIGHT	MRK	DESCRIPTION	LENGTH	GRADE	REMARK	WEIGHT
QT	MQE	DESCRIPTION	LONG.	NUANCE	REMARQUE	MASSE	MQE	DESCRIPTION	LONG.	NUANCE	REMARQUE	MASSE
1	MI18	PL 9.53 X 415	647	300W		18.3						

HEIGHT OF TOWER / HAUTEUR DE LA TOUR	10'	15'	20'	25'	30'	35'	40'	45'	50'	55'	60'	65'	70'	75'	80'
QUANTITY REQUIRED / QUANTIT REQUISE	1	1	1	1	1	1	1	1	1	1	1	1	1	1	1
ERECTION DRAWING / DESSIN DE MONTAGE	08990-SM-01	08990-SM-02	08990-SM-03	08990-SM-04	08990-SM-05	08990-SM-06	08990-SM-07	08990-SM-08	08990-SM-09	08990-SM-10	08990-SM-11	08990-SM-12	08990-SM-13	08990-SM-14	08990-SM-15

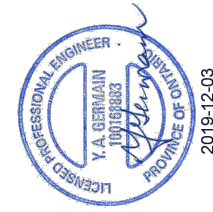
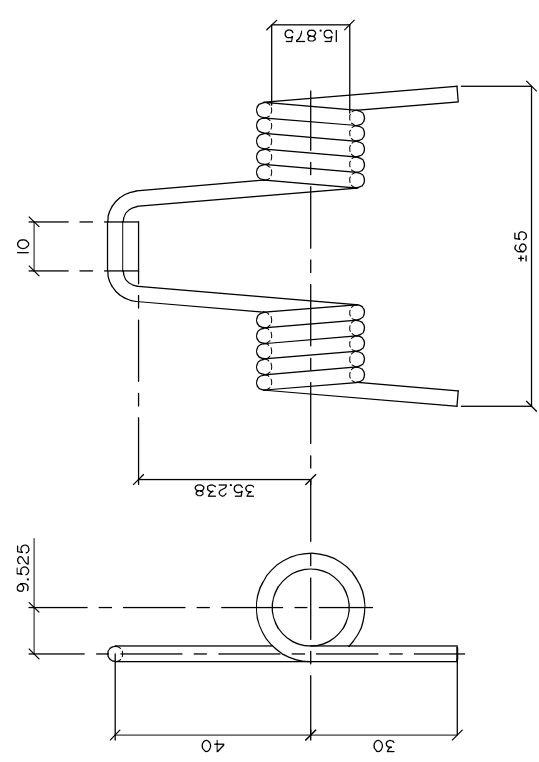

No	CONFORME A CSA S37-18 (CIMA+)	2019/11/28
REVISION	DATE	
	Pêches et Océans Canada	Fisheries and Oceans Canada
	Garde côtière	Coast Guard

DESSIN MICHEL VACHON INC. DESSIN DE STRUCTURES METALLIQUES 11-1000, RUE CADILLAC TEL: 514-746-7949	
STEEL TOWERS / TOURS D'ACIER	
MATERIAL: MATERIEL:	ANSI HOLES: TROUS:
DRAWN: M.VACHON	CHECKED: M.VACHON
SCALE: 1 = 1	FILE: 08990-SA
FINISH: -	S.N. FINI: -
DATE: 2006/01/11	DATE: 2006/01/11
DRAWING: M122	DESSIN: M122

QTY	MRK	DESCRIPTION	LENGTH	GRADE	REMARK	WEIGHT	QTY	MRK	DESCRIPTION	LENGTH	GRADE	REMARK	WEIGHT
QT	MOE	DESCRIPTION	LONG.	NUANCE	REMARQUE	MASSE	QT	MOE	DESCRIPTION	LONG.	NUANCE	REMARQUE	MASSE
1	M122	● 3.18	φ	X	±755	304SS	SPRING/RESSORT	0.05					

WEIGHT / MASSE: 0.05 KG

HEIGHT OF TOWER / HAUTEUR DE LA TOUR	10'	15'	20'	25'	30'	35'	40'	45'	50'	55'	60'	65'	70'	75'	80'
QUANTITY REQUIRED / QUANTITE REQUISE	10	10	10	10	10	10	10	10	10	10	10	10	10	10	10
ERECTION DRAWING / DESSIN DE MONTAGE	08890-SM-01	08890-SM-02	08890-SM-03	08890-SM-04	08890-SM-05	08890-SM-06	08890-SM-07	08890-SM-08	08890-SM-09	08890-SM-10	08890-SM-11	08890-SM-12	08890-SM-13	08890-SM-14	08890-SM-15

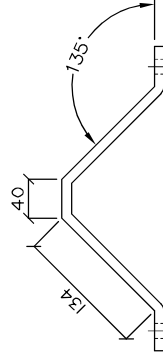
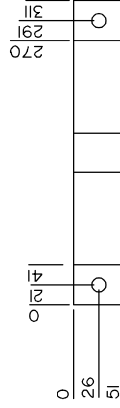

I	CONFORME A CSA S37-18 (CIMA+)	2019/11/28
No	REVISION	DATE

Pêches et Océans
 Canada
 Fisheries and Oceans
 Canada

Garde côtière
Coast Guard

QTY	MRK	DESCRIPTION	LENGTH	GRADE	REMARK	WEIGHT	DESCRIPTION	LENGTH	GRADE	REMARK	WEIGHT
QT	MQE	DESCRIPTION	LONG.	NUANCE	REMARQUE	MASSE	DESCRIPTION	LONG.	NUANCE	REMARQUE	MASSE
1	E123	FB 9-53 X 51	390	300W							

STEEL TOWERS / TOURS D'ACIER	
MATERIAL:	G40.21M
HOLES:	9/16" φ
FINISH:	GALV.
DESIGN:	I.T.G.
DATE:	2010/05/12
FILE:	08990-SA
DOSSIER:	E123

HEIGHT OF TOWER / HAUTEUR DE LA TOUR	10'	15'	20'	25'	30'	35'	40'	45'	50'	55'	60'	65'	70'	75'	80'
QUANTITY REQUIRED / QUANTITE REQUISE	8	8	8	8	8	8	8	8	8	8	8	8	8	8	8
ERECTION DRAWING / DESSIN DE MONTAGE	08990-SM-01	08990-SM-02	08990-SM-03	08990-SM-04	08990-SM-05	08990-SM-06	08990-SM-07	08990-SM-08	08990-SM-09	08990-SM-10	08990-SM-11	08990-SM-12	08990-SM-13	08990-SM-14	08990-SM-15

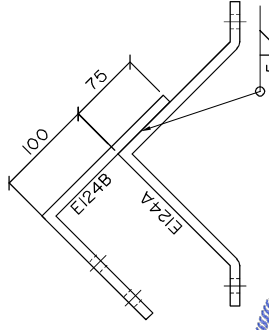
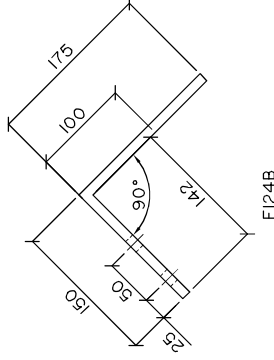
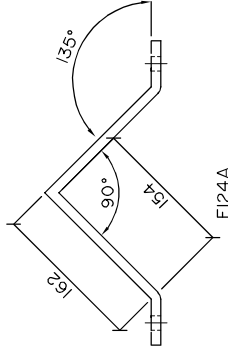
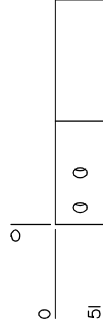
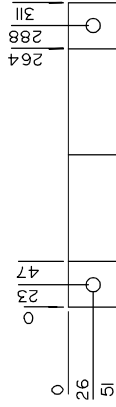

E124A + E124B
2019-12-03

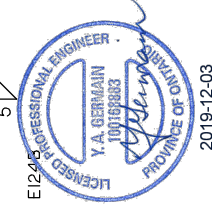

2019-12-03

I	CONFORME A CSA S37-18 (CIMA+)	2019/11/28
O	POUR FABRICATION	2010/06/04
No	REVISION	DATE

Pêches et Océans
Canada

Garde côtière
Coast Guard

QTY	MRK	DESCRIPTION	LENGTH	GRADE	REMARK	WEIGHT	QTY	MRK	DESCRIPTION	LENGTH	GRADE	REMARK	WEIGHT
QT	MQE	DESCRIPTION	LONG.	NUANCE	REMARQUE	MASSE	QT	MQE	DESCRIPTION	LONG.	NUANCE	REMARQUE	MASSE
1	E124A	FB 9.53 X 51	402	300W									
1	E124B	FB 9.53 X 51	308	300W									

STEEL TOWERS / TOURS D'ACIER

MATERIAL:	G40.21M	HOLES:	9/16" φ	U.N. FINISH:	GALV.
DESIGN:	I.T.G.	PROJ. NO.:	2010/05/12	DATE:	
SCALE:	1 = 5	FILE:	08990-SA	DRAWING:	
CHELÉE:		DOSSIER:		DESSIN:	E124

HEIGHT OF TOWER / HAUTEUR DE LA TOUR	10'	15'	20'	25'	30'	35'	40'	45'	50'	55'	60'	65'	70'	75'	80'
QUANTITY REQUIRED / QUANTITE REQUISE	2	2	2	2	2	2	2	2	2	2	2	2	2	2	2
ERECTION DRAWING / DESSIN DE MONTAGE	08990-SM-01	08990-SM-02	08990-SM-03	08990-SM-04	08990-SM-05	08990-SM-06	08990-SM-07	08990-SM-08	08990-SM-09	08990-SM-10	08990-SM-11	08990-SM-12	08990-SM-13	08990-SM-14	08990-SM-15

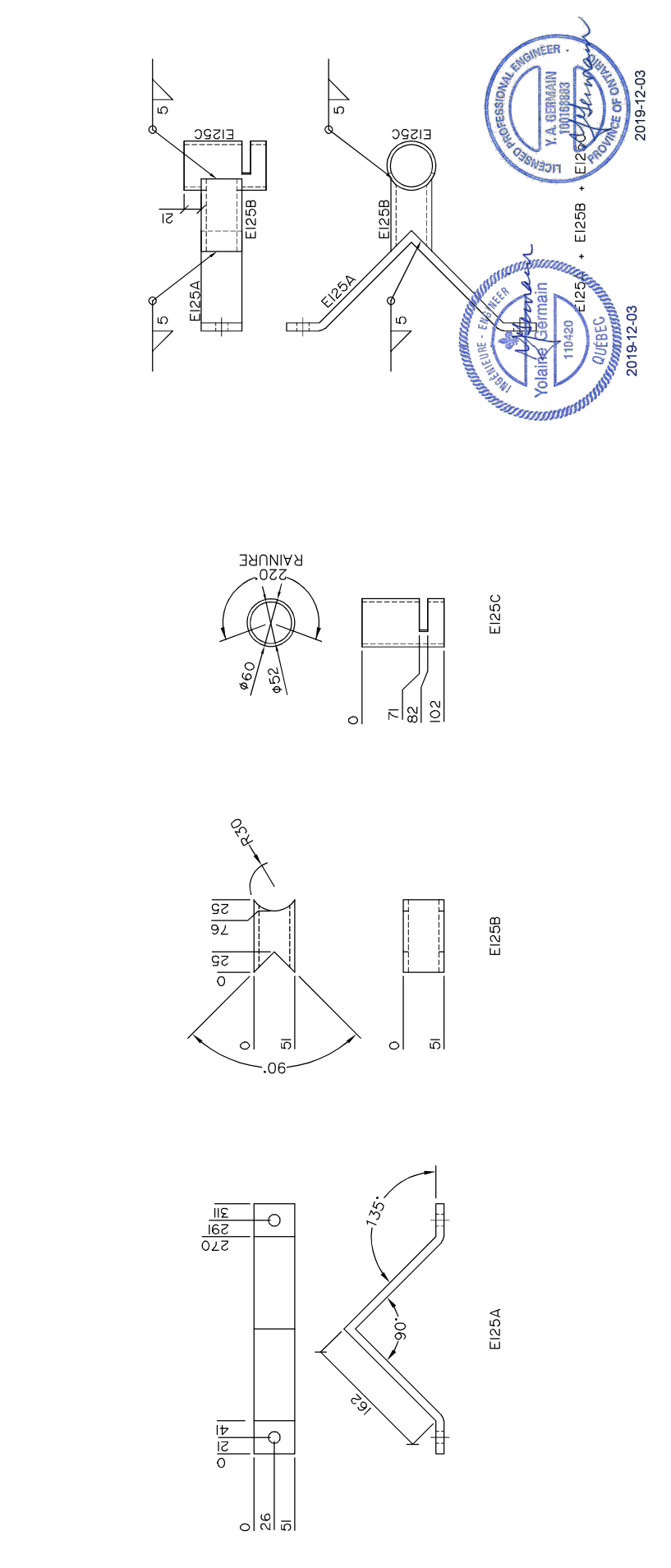

I	CONFORME A CSA S37-18 (CIMA+)	2019/11/28
No	REVISION	DATE

Pêches et Océans
 Canada
 Fisheries and Oceans
 Canada
 Garde côtière
 Coast Guard

QTY	MRK	DESCRIPTION	LENGTH	GRADE	REMARK	WEIGHT	DESCRIPTION	LENGTH	GRADE	REMARK	WEIGHT
QT	MQE	DESCRIPTION	LONG.	NUANCE	REMARQUE	MASSE	DESCRIPTION	LONG.	NUANCE	REMARQUE	MASSE
1	E125A	FB 9.53 X 51	406	300W							
1	E125B	HSS 51X51 X 6.4	90	300W							
1	E125C	HSS 60φ X 4	102	300W							

STEEL TOWERS / TOURS D'ACIER
 MATERIAL: G40.21M
 FINISH: GALV.
 HOLE: 9/16" φ
 U.N. FINISH: GALV.
 DRAWING: I.T.G.
 CHECKED: DATE: 2010/05/12
 DESIGNED: I.T.G.
 SCALE: 1 = 5
 FILE: 08990-SA
 DRAWING: E125
 DESSIN:

HEIGHT OF TOWER / HAUTEUR DE LA TOUR	10'	15'	20'	25'	30'	35'	40'	45'	50'	55'	60'	65'	70'	75'	80'
QUANTITY REQUIRED / QUANTITE REQUISE	0	0	0	0	0	0	0	0	0	0	0	0	0	0	8
ERECTION DRAWING / DESSIN DE MONTAGE	08990-SM-01	08990-SM-02	08990-SM-03	08990-SM-04	08990-SM-05	08990-SM-06	08990-SM-07	08990-SM-08	08990-SM-09	08990-SM-10	08990-SM-11	08990-SM-12	08990-SM-13	08990-SM-14	08990-SM-15

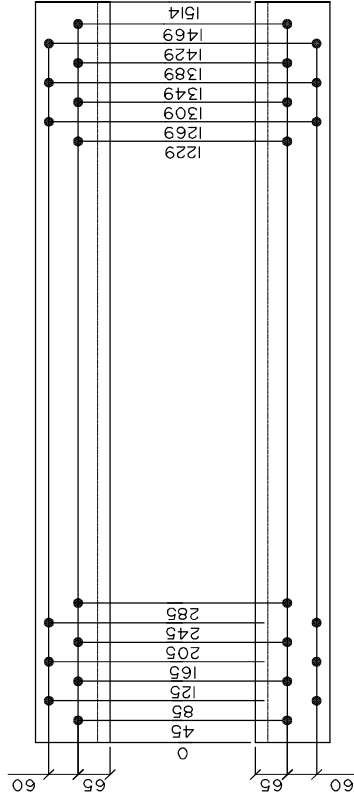

2019-12-03

No	REVISION	DATE
-	-	-
Pêches et Océans Canada Garde côtière Coast Guard		



STEEL TOWERS / TOURS D'ACIER

MATERIAL / MATÉRIEL	G40.21M	HOLES / TROUS	13/16"φ	UN. FINISH / S.N. FINI	GALV.
DRAWN / DESSINÉ	B. ABRAN	CHECKED / VÉRIFIÉ	Y. GERMAIN	DATE	2019-11-28
SCALE / ÉCHELLE	1 = 10	FILE / DOSSIER	08990-SA	DRAWING / DESSIN	V126

QTY	MRK	DESCRIPTION	LENGTH	GRADE	REMARK	WEIGHT	MRK	DESCRIPTION	LENGTH	GRADE	REMARK	WEIGHT
QT	MQE	DESCRIPTION	LONG.	NUANCE	REMARQUE	MASSE	MQE	DESCRIPTION	LONG.	NUANCE	REMARQUE	MASSE
1	V126	L 152 25	1514	350W		84.5						
WEIGHT / MASSE: 168.9 Kg												

HEIGHT OF TOWER / HAUTEUR DE LA TOUR	10'	15'	20'	25'	30'	35'	40'	45'	50'	55'	60'	65'	70'	75'	80'
QUANTITY REQUIRED / QUANTITE REQUISE	0	0	0	0	0	0	0	0	0	0	4	0	0	0	0
ERECTION DRAWING / DESSIN DE MONTAGE	08990-SM-01	08990-SM-02	08990-SM-03	08990-SM-04	08990-SM-05	08990-SM-06	08990-SM-07	08990-SM-08	08990-SM-09	08990-SM-10	08990-SM-11	08990-SM-12	08990-SM-13	08990-SM-14	08990-SM-15

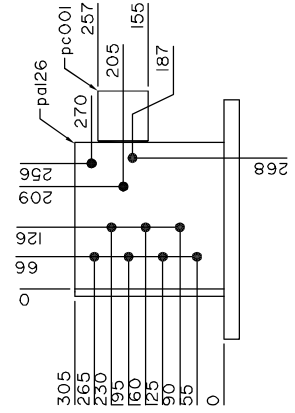
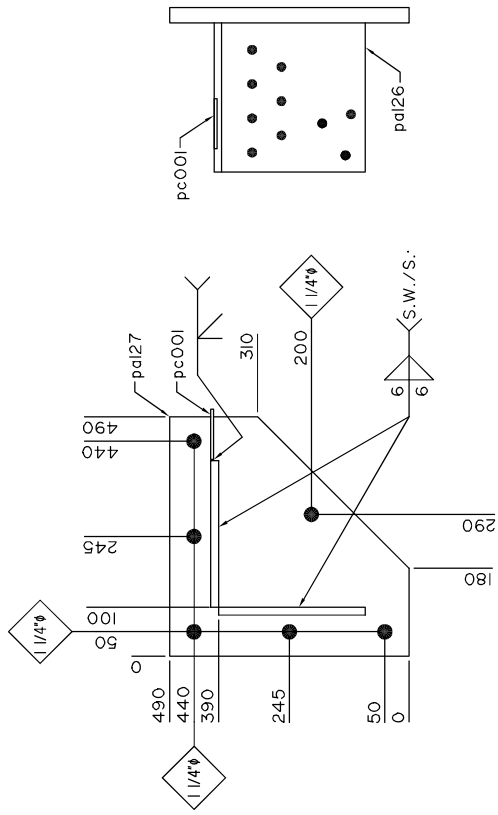

No	REVISION	DATE
-	-	-



 Pêches et Océans
 Canada
 Garde côtière
 Coast Guard



STEEL TOWERS / TOURS D'ACIER
 MATERIAL: G40.21M UN: 13/16"φ
 DRAWN: B.ABRAN TRUUS: Y.GERMAIN S.N. FINI: GALV.
 CHECKED: Y.GERMAIN DATE: 2019-11-28
 SCALE: 1 = 10 FILE: 08990-SA DRAWING: B127
 SHELLÉ: DOSSIER: DESSIN:

QTY	MRK	DESCRIPTION	LENGTH	GRADE	REMARK	WEIGHT	WEIGHT
QT	MQE	DESCRIPTION	LONG.	NUANCE	REMARQUE	MASSE	MASSE
1	pal27	PL 31.8 X 490	490	300W		59.9	83.2
2	pal26	FB 15.9 X 305	300	300W	ASS. FB127	22.8	
1	pc001	PL 6.35 X 102	102	300W		0.5	

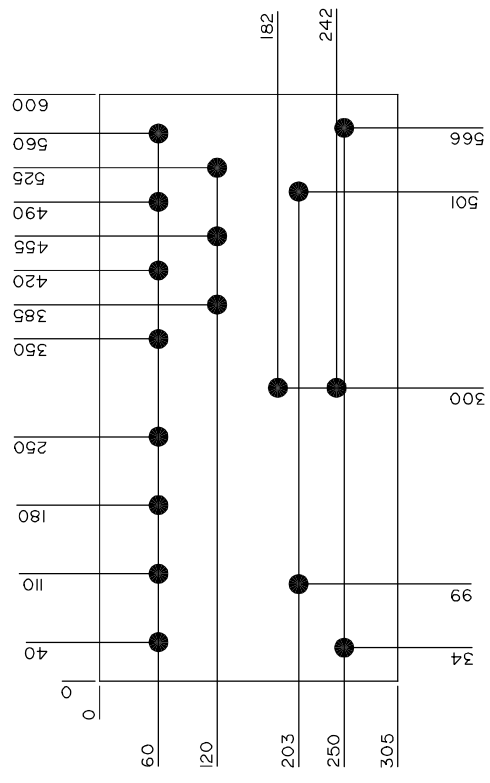
HEIGHT OF TOWER / HAUTEUR DE LA TOUR	10'	15'	20'	25'	30'	35'	40'	45'	50'	55'	60'	65'	70'	75'	80'
QUANTITY REQUIRED / QUANTITE REQUISE	0	0	0	0	0	0	0	0	0	0	8	0	0	0	0
ERECTION DRAWING / DESSIN DE MONTAGE	08990-SM-01	08990-SM-02	08990-SM-03	08990-SM-04	08990-SM-05	08990-SM-06	08990-SM-07	08990-SM-08	08990-SM-09	08990-SM-10	08990-SM-11	08990-SM-12	08990-SM-13	08990-SM-14	08990-SM-15



No	REVISION	DATE
 Pêches et Océans Canada		
Garde côtière Coast Guard		

STEEL TOWERS / TOURS D'ACIER		
MATERIAL: / MATÉRIEL:	G-40, 21M	U.N. FINISH: / S.N. FINI:
DRAWN: / DESSIN:	B. ABRAN	CHECKED: / VÉRIFIÉ:
SCALE: / ÉCHELLE:	1 = 5	FILE: / DOSSIER:
	08990-SA	DRAWING: / DESSIN:
		M128

QTY	MRK	DESCRIPTION	LENGTH	GRADE	REMARK	WEIGHT	REMARK	LENGTH	GRADE	DESCRIPTION	WEIGHT
QT	MQE	DESCRIPTION	LONG.	NUANCE	REMARQUE	MASSE	REMARQUE	LONG.	NUANCE	DESCRIPTION	MASSE
1	M128	FB 15.9 X 305	600	300W		22.8					

DATE: / DATE:	2019-11-28
DATE: / DATE:	2019-11-28
DATE: / DATE:	2019-11-28